









Rosemount™ 8750W North America Zone Approval Document



Rosemount 8750W Magnetic Flowmeter Platform

Order Code	8750W Magnetic Flowmeter Platform Rating	Region	Agency	Certification Number
-	Ordinary Locations*	USA, Canada, EU, CU**	CSA, EAC	70081467X(CSA)
Z1	ATEX Non-Sparking or Increased Safety and Dust for Non-Flammable Fluids	EU	DEKRA	15ATEX0003 X
ND	ATEX Dust	EU	DEKRA	15ATEX0003 X
Z2	InMetro Non-Sparking and Dust for Non-Flammable Fluids	Brazil	DNV GL - INMETRO	DNV 18.0082 X
Z3	NEPSI Non-Sparking and Dust for Non-Flammable Fluids	China	NEPSI	GYJ15.1228X
Z5	DIP (Dust-Ignitionproof) Class II and III, Div 1. Non-Incendive, Class I Div 2 for Non-Flammable Fluids	USA	CSA	70081467X(CSA)
Z6	DIP (Dust-Ignitionproof) Class II and III, Div 1. Non-Incendive, Class I Div 2 for Non-Flammable Fluids	USA & Canada	CSA	70081467-X
Z7	IECEX Non-Sparking or Increased Safety and Dust for Non-Flammable Fluids	Global	DEKRA	IECEX DEK 15.0001X
NF	IECEX Dust	Global	DEKRA	IECEX DEK 15.0001X
Z9	KTL Non-Sparking and Dust for Non-Flammable Fluids	Korea	KTL	***
*Complies with only the local country Product safety, Electromagnetic, Pressure and other applicable regulations. Cannot be used in a classified or zoned hazardous location environment.				
** Customs Union (Russia, Belarus and Kazakhstan)				
*** Future				

Approval Markings and Logos

Symbol	Marking or Symbol Name	Region	Meaning of Marking or Symbol
	CE	European Union	Compliance with all applicable European Union Directives.
	ATEX	European Union	Compliance with Equipment and Protective systems intended for use in Potentially Explosive Atmospheres directive (ATEX) (94/9/EC)
	C-tick	Australia	Compliance with Australian applicable electromagnetic compatibility standards
	CSA	US = United States C = Canada	Indicates that the product was tested and has met the applicable certification requirements for the noted countries.
	Eurasian Conformity (EAC)	Eurasian Customs Union (Russia, Belarus and Kazakhstan)	Compliance with all of the applicable technical regulations of the EAC Customs Union
	DNV GL - INMETRO	Brazil	Compliance with all of the applicable technical regulations of Brazil.
	NEPSI	China	Compliance with all of the applicable technical regulations of China.
	KTL	Korea	Compliance with all of the applicable technical regulations of Korea.

Ordinary Location labels will be marked with CE, C-tick, CSA and EAC logos.

European Directive Information

The most recent revision of the EU Declaration of Conformity can be found at www.emerson.com.

Certifications

Canadian Standards Association (CSA)

Ordinary Location Certification

The transmitter and flowtube have been examined and tested to determine that the design meets basic electrical, mechanical, and fire protection requirements by CSA, a nationally recognized testing laboratory (NRTL) as accredited by the Federal Occupational Safety and Health Administration (OSHA).

CLASS 2258 02 - PROCESS CONTROL EQUIPMENT - For Hazardous Locations – To Canadian Requirements.

Z6, Z5	Class I, Division 2, Groups A, B, C and D; T4 (Non-Incendive)
ZC	Ex nA [ic] IIC T4 Gc (Transmitter – DC Powered Only)
ZC	Ex ec [ic] IIC T4 Gc (Transmitter – DC Powered Only)
ZC	Ex nA ic [ic] IIC T4 Gc (8750WDMW Transmitter – DC Powered Only)
ZC	Ex ec ic [ic] IIC T4 Gc (8750WDMWTransmitter – DC Powered Only)
ZC	Ex nA ic IIC T5...T4 Gc (Flow Tube)
ZC	Ex ec ic IIC T5...T4 Gc (Flow Tube)
Z6, Z5	Class II, Division 1, Groups E, F and G, T5; Class III (Dust Ignition Proof)
ZC	Ex tc IIIC T80 °C...T130 °C Dc (Transmitter and Flow Tube)
ZC	Ex tc IIIC T80 °C Dc (8750WDMW Transmitter)

CLASS 2258 82 - PROCESS CONTROL EQUIPMENT - For Hazardous Locations –To US Requirements

Z6, Z5	Class I, Division 2, Groups A, B, C and D; T4 (Non-Incendive)
ZC	Class I, Zone 2, AEx nA [ic] IIC T4 Gc (Transmitter – DC Powered Only)
ZC	Class I, Zone 2, AEx ec [ic] IIC T4 Gc (Transmitter – DC Powered Only)
ZC	Class I, Zone 2, AEx nA ic [ic] IIC T4 Gc (8750WDMW Transmitter – DC Powered Only)
ZC	Class I, Zone 2, AEx ec ic [ic] IIC T4 Gc (8750WDMWTransmitter – DC Powered Only)
ZC	Class I, Zone 2, AEx nA ic IIC T5...T4 Gc (Flow Tube)
ZC	Class I, Zone 2, AEx ec ic IIC T5...T4 Gc (Flow Tube)
Z6, Z5	Class II, Division 1, Groups E, F and G, T5; Class III (Dust Ignition Proof)
ZC	Class II, Zone 22, AEx tc IIIC T80°C... 130°C Dc (Transmitter and Flow Tube)
ZC	Ex tc IIIC T80 °C Dc (8750WDMW Transmitter)

8750W Magnetic Flowtube and Transmitter

Z6, Z5	All Flowtubes and Integral or Remote Mount Transmitters (Transmitter mount codes T or R) Non-Incendive for Class I, Division 2, Groups ABCD: T4 Dust-Ignition Proof for Class II/III, Division 1, Groups EFG: T5 -29°C ≤ Ta ≤ 60°C Enclosure Type 4X, IP66/68 (IP68 flowtube only with Remote mount transmitter) Install per drawing 8750W-1051
---------------	--

8750W Magnetic Flowtube and Transmitter

Z6, Z5	All Flowtubes and Wall Mount Transmitter (Transmitter mount code W) Non-Incendive for Class I, Division 2, Groups ABCD: T4 Dust-Ignition Proof for Class II/III, Division 1, Groups EFG: T4 -29°C ≤ Ta ≤ 40°C Enclosure Type 4X, IP66/68/69K (IP68 flowtube only; IP69K Transmitter mount code WDMW) Install per drawing 8750W-1051
---------------	--

Special Conditions of Safe Use for Class/Division

1. Flow tube to be used only in a non-flammable process.

Special Conditions for Safe Use (X) for Class Zone:

1. When "Special Paint Systems" are applied, instructions for safe use regarding potential electrostatic charging hazard have to be followed.
2. Conduit entries must be installed to maintain the enclosure ingress rating of IP66 (Transmitter and Flow Tube), IP68 (Flow Tube) or IP69K (Flow Tube or 8750W...W transmitter) as applicable.
3. Terminals for the output signals of the Magnetic Flow Transmitters, cannot withstand the 500 V isolation test between signal and ground, due to integral transient protection. This must be taken into account upon installation.
4. When utilizing the keypad of Magnetic Flow Transmitter Model 8750W...W, instructions for safe use regarding potential electrostatic charging hazard have to be followed.

Rosemount 8750W Magnetic Flowmeter Platform IECEX & ATEX Approval Document

14 September 2018,
8750W-AP02, Rev AC

1. Equipment Markings – See section VI in the tables on the following pages
 - a. Type Examination Certificate (ATEX): DEKRA 15ATEX0003 X
 - b. Certificate of Conformity (IECEX): IECEX DEK 15.0001X
2. Required Documentation:
 - a. 8750W-2052 Installation Drawing Model 8750W ATEX/IECEX Hazardous (Ex) Locations
3. Referenced Documentation:
 - a. 00825-0X00-4444.pdf, Transmitter Quick Installation Guide (Where X = Communications Protocol Code)
 - b. 00825-0300-4750.pdf, Sensor Quick Installation Guide
4. The Required and Referenced Documents listed above address the following items:
 - a. Instructions for safety i.e.
 - i. Putting into service
 - ii. Use
 - iii. Assembling and dismantling
 - iv. Maintenance, overhaul and repair
 - v. Installation
 - vi. Adjustment
 - b. Where necessary, training instructions
 - c. Details which allow a decision to be made as to whether the equipment can be used safely in the intended area under the expected operating conditions
 - d. Electrical parameters, maximum surface temperatures and other limit values
 - i. Electrical –
 1. See document 8750W-2052

Rosemount 8750W Flow Transmitter	
<i>Power input</i>	90 - 250VAC, 0.45A, 40VA 12 - 42VDC, 1.2A, 15W
<i>Pulsed circuit</i>	<i>Internally powered (Active): Outputs up to 12VDC, 12.1mA, 73mW</i> <i>Externally powered (Passive): Input up to 28VDC, 100mA, 1W</i>
<i>4-20mA output circuit</i>	<i>Internally Powered (Active): Outputs up to 25mA, 24VDC, 600mW</i> <i>Externally Powered (Passive): Input up to 25mA, 30VDC, 750mW</i>
<i>MODBUS</i>	<i>Internally Powered (Active): Outputs up to 100mA, 3.3VDC, 100mW</i>
<i>Fieldbus</i>	<i>Externally Powered (Passive): 9-32VDC,</i>
<i>Profibus</i>	<i>Externally Powered (Passive): 9-32VDC,</i>
<i>Um</i>	250V
<i>Coil excitation output</i>	500mA, 40V max, 9W max
Rosemount 8750W Flowtube⁽¹⁾	
<i>Coil excitation input</i>	500mA, 40V max, 20W max
<i>Electrode circuit</i>	5V, 200uA, 1mW

(1) Provided by the transmitter

Special Conditions for Safe Use (X):

- i. Terminals for the output signals of the Magnetic Flow Transmitters, cannot withstand the 500 V isolation test between signal and ground, due to integral transient protection. This must be taken into account upon installation.
 - ii. When utilizing the keypad of Magnetic Flow Transmitter Model 8750W...W, instructions for safe use regarding potential electrostatic charging hazard have to be followed.
 - iii. When "Special Paint Systems" are applied, instructions for safe use regarding potential electrostatic charging hazard have to be followed.
 - iv. Conduit entries must be installed to maintain the enclosure ingress rating of IP66 (Transmitter and Flow Tube), IP68 (Flow Tube) or IP69K (Flow Tube or 8750W...W transmitter) as applicable.
- e. Where necessary, the essential characteristics of tools which may be fitted to the equipment
- i. No proprietary tools required.
- f. List of the standards, including the issue date, with which the equipment is declared to comply:
- i. ATEX - EN 60079-0 : 2012 + A11 : 2013, EN 60079-7: 2015, EN 60079-11 : 2012, EN 60079-15 : 2010, EN 60079-31 : 2014
 - ii. IECEx - IEC 60079-0: 2011, IEC 60079-7: 2015, IEC 60079-11: 2011, IEC 60079-15: 2010, IEC 60079-31: 2013
- g. Supply wire requirements;
Use 10 - 18 AWG wire rated for the proper temperature of the application. For wire 10 - 14 AWG use lugs or other appropriate connectors. For connections in ambient temperatures above 122°F (50 °C), use a wire rated for 194 °F (90 °C).
- h. Contact address; Emerson -Rosemount, Micro Motion Inc
 12001 Technology Drive
 Eden Prairie, MN 55344, United States of America

Rosemount 8750W Magnetic Flowmeter Platform IECEx & ATEX Approval Document

14 September 2018,
8750W-AP02, Rev AC

Nomenclature Magnetic Flow Meter System Model 8750W and electrical data

8750W ... R 1 A 2 ... F 005 ... Z1 ... M4 ... AX ... V1 ... R50
 I II III IV V VI VII VIII IX X XI XII

Designation	Explanation	Value	Explanation
I	Model	8750W	Flow Meter System Model 8750W
II	Transmitter Mount	R T W	Remote Mount Integral Mount Wall Mount
III	Transmitter Power Supply	1 2	AC (90 - 250 Vac, 50 / 60 Hz), not for Ex nA or Ex ec DC (12 - 42 Vdc)
IV	Transmitter Outputs	A M F P 0	Non-I.S.: 4 - 20 mA with digital HART Protocol & Scalable Pulse Output Non-I.S.: Modbus RS-485 I.S.: Foundation Fieldbus / FISCO Intrinsically Safe & Intrinsically Safe Scalable Pulse Output I.S.: Profibus & Intrinsically Safe Scalable Pulse Output Spare Flow Tube, no Transmitter
V	Conduit Entries	1 2 4 5	½-14 NPT female CM20, M20 female ½-14 NPT female, 8750W...R / T only CM20, M20 female, 8750W...R / T only
VI	Electrode Type	A, B, E, F 0	Seal of electrodes comply with IEC 61010-1. Spare Transmitter, No Flow Tube
VII	Line Size	005 to 480 000	½" NPS (15 mm) to 48" NPS (1200 mm) Spare Transmitter, no Flow Tube
VIII	Safety Approvals	Z1 ATEX	Transmitter Models 8750W...R and 8750W...T: Ⓢ II 3 G Ex nA [ic] IIC T4 Gc * Ⓢ II 3 G Ex ec [ic] IIC T4 Gc * Ⓢ II 3 D Ex tc IIIC T80 °C...T130 °C Dc ** Transmitter Model 8750W...W: Ⓢ II 3 G Ex nA ic [ic] IIC T4 Gc * Ⓢ II 3 G Ex ec ic [ic] IIC T4 Gc * Ⓢ II 3 D Ex tc IIIC T80 °C Dc ** Flow Tube: Ⓢ II 3 G Ex nA ic IIC T5...T4 Gc Ⓢ II 3 G Ex ec ic IIC T5...T4 Gc Ⓢ II 3 D Ex tc IIIC T80 °C...T130 °C Dc
		Z7 / Z9 IECEx	Transmitter Models 8750W...R and 8750W...T: Ex nA [ic] IIC T4 Gc * Ex ec [ic] IIC T4 Gc * Ex tc IIIC T80 °C...T130 °C Dc ** Transmitter Model 8750W...W: Ex nA ic [ic] IIC T4 Gc * Ex ec ic [ic] IIC T4 Gc * Ex tc IIIC T80 °C Dc ** Flow Tube: Ex nA ic IIC T5...T4 Gc Ex ec ic IIC T5...T4 Gc Ex tc IIIC T80 °C...T130 °C Dc
		ND ATEX	Transmitter Models 8750W...R and 8750W...T + Flow Tube: Ⓢ II 3 D Ex tc IIIC T80 °C...T130 °C Dc ** Ⓢ II (3) G [Ex ic Gc] IIC *** Transmitter Model 8750W...W: Ⓢ II 3 D Ex tc IIIC T80 °C Dc ** Ⓢ II (3) G [Ex ic Gc] IIC ***
		NF IECEx	Transmitter Models 8750W...R and 8750W...T + Flow Tube: Ex tc IIIC T80 °C...T130 °C Dc ** [Ex ic Gc] IIC *** Transmitter Model 8750W...W: Ex tc IIIC T80 °C Dc ** [Ex ic Gc] IIC ***
			NOTE: * Model 8750W Transmitter DC Power Supply only ** Model 8750W Transmitter AC and DC Power Supply *** Intrinsically Safe Output (see IV) option only

Nomenclature Magnetic Flow Meter System Model 8750W and electrical data (continued)

8750W ... R 1 A 2 ... F 005 ... Z1 ... M4 ... AX ... V1 ... R50
 I II III IV V VI VII VIII IX X XI XII

Designation	Explanation	Value	Explanation
IX	Transmitter Display	-- M4 M5	Without LOI and keypad LOI (+keypad for Transmitter model 8750W...W only) Display
X	Transmitter Discrete Input / Output	AX	Two Discrete Channels (DI/DO 1, DO 2)
XI	Specials Paint	Vx	Special Paint Systems *** NOTE: *** Subject to special conditions for safe use.
XII	Remote Cable	Rxx ****	Standard Temperature Component NOTE: **** Length = XX x 10ft., max 500 ft.



ROSEMOUNT™

EU Declaration of Conformity No: RFD 1098 Rev. L

We,

**Emerson – Rosemount, Micro Motion Inc.
12001 Technology Drive
Eden Prairie, MN 55344
USA**

declare under our sole responsibility that the product(s),

Rosemount Model 8750W Magnetic Flowmeters

to which this declaration relates, is in conformity with the provisions of the European Union Legislation, including the latest amendments, as shown in the attached schedule.

Assumption of conformity is based on the application of harmonized or applicable technical standards and, when applicable or required, a European Union Legislation notified body certification, as shown in the attached schedule.

(signature)

14 February 2019

(date of issue)

Mark Fleigle

(name - printed)

Vice President - Technology and Product Development

(function name - printed)



ROSEMOUNT™

Schedule
EU Declaration of Conformity RFD 1098 Rev. L

LVD Directive 2014/35/EU

All Models: EN 61010-1: 2010

EMC Directive 2014/30/EU

All Models: EN 61326-1: 2013

PED Directive 2014/68/EU

Model 8750W Magnetic Flowmeter Sensor with Option “PD”, in Line Sizes 1.5” – 24”

Equipment without the ‘PD’ option is NOT PED compliant and cannot be used in the EEA without further assessment unless the installation is exempt under Article 1, paragraph 2 of the PED Directive 2014/68/EU.

QS Certificate of Assessment - 12317-2018-CE-USA-ACCREDIA
Module H Conformity Assessment
ASME B31.3: 2016

Model 8750W in Line Sizes 0.5” – 1.0”

Sound Engineering Practice
ASME B31.3: 2016



ROSEMOUNT™

Schedule
EU Declaration of Conformity RFD 1098 Rev. L

ATEX Directive 2014/34/EU

Model 8750W Magnetic Flowmeter Transmitter and Sensors

CERTIFICATE: DEKRA 15ATEX0003 X

Equipment Marking Summary:



- II 3 G Ex nA [ic] IIC T4 Gc
- II 3 G Ex ec [ic] IIC T4 Gc
- II 3 G Ex nA ic IIC T5...T4 Gc
- II 3 G Ex ec ic IIC T5...T4 Gc
- II 3 G Ex nA ic [ic] IIC T4 Gc
- II 3 G Ex ec ic [ic] IIC T4 Gc
- II 3 G [Ex ic Gc] IIC
- II 3 D Ex tc IIIC T 80°C Dc
- II 3 D Ex tc IIIC T 80°C...T 130°C Dc

EN 60079-0: 2012 +A11:2013
EN 60079-15: 2010

EN 60079-7: 2015
EN 60079-31: 2014

EN 60079-11: 2012

PED Notified Body

DNV GL Business Assurance S.r.l. [Notified Body Number: 0496]
Via Energy Park 14
Vimercate, 20871 Italy

PAGE	TITLE
2	GAS ENVIRONMENT - EPL Gc SENSOR WITH ALLOWED INTEGRAL MOUNT EPL Gc TRANSMITTERS
3	GAS ENVIRONMENT - EPL Gc SENSOR WITH ALLOWED REMOTE MOUNT EPL Gc TRANSMITTERS
4	DUST ENVIRONMENT - EPL Dc SENSOR WITH ALLOWED INTEGRAL MOUNT EPL Dc TRANSMITTERS
5	DUST ENVIRONMENT - EPL Dc SENSOR WITH ALLOWED REMOTE MOUNT EPL Dc TRANSMITTERS
6	GAS AND DUST ENVIRONMENT - EPL Gc AND EPL Dc - SENSOR TEMPERATURE CODE VS. PROCESS TEMPERATURE AND INGRESS PROTECTION RATINGS
7	GAS ENVIRONMENT - EPL Gc COIL AND ELECTRODE CIRCUIT WIRING
8	DUST ENVIRONMENT - EPL Dc COIL AND ELECTRODE CIRCUIT WIRING
9	GAS AND DUST ENVIRONMENT - OUTPUT WIRING
10	GAS ENVIRONMENT - INTRINSICALLY SAFE ENTITY CONCEPTS
11	GAS ENVIRONMENT - FISCO CONCEPT

⚠ WARNING: EXPLOSION HAZARD - PRODUCT INSTALLATION SHALL COMPLY WITH INFORMATION AS STATED IN THIS DOCUMENT.

1. WIRING METHOD SUITABLE FOR APPROPRIATE ZONE AND PROTECTION TYPE.
2. TRANSMITTER MUST NOT BE CONNECTED TO EQUIPMENT GENERATING MORE THAN 250V.
3. COMPONENTS REQUIRED TO HAVE HAZARDOUS (Ex) LOCATION APPROVAL MUST BE APPROVED FOR THE GAS GROUP APPROPRIATE TO AREA CLASSIFICATION.

4. FOR ALL INSTALLATIONS MAXIMUM TERMINAL TIGHTENING TORQUE IS 10.6 IN LBS.

5. THE ELECTRODE CIRCUIT AND WIRING MUST BE INSTALLED AS INTRINSICALLY SAFE WHEN THE FLOWTUBE IS INSTALLED IN A HAZARDOUS (Ex) AREA WITH AN EQUIPMENT PROTECTION LEVEL (EPL) OF Gc.

6. NO REVISION TO THIS DRAWING WITHOUT PRIOR CSA APPROVAL.

7. USA-INSTALLATION SHALL BE IN ACCORDANCE WITH THE NATIONAL ELECTRIC CODE (NEC), NFPA-70, AND ANSI/ISA-RP1206.01. CANADA-INSTALLATION SHALL BE IN ACCORDANCE WITH THE CANADIAN ELECTRICAL CODE (CEC) PART I (C22.1).

8. - WARNING - EXPLOSION HAZARD - DO NOT DISCONNECT WHILE CIRCUIT IS LIVE UNLESS AREA IS KNOWN TO BE NON-HAZARDOUS.
 - AVERTISSEMENT - RISQUE D'EXPLOSION. NE PAS DEBRANCHER TANT QUE LE CIRCUIT EST SOUS TENSION, A MOINS QU'IL NE S'AGISSE D'UN EMPLACEMENT NON DANGEREUX.
 - WARNING - AFTER DE-ENERGIZING, DELAY 10 MINUTES BEFORE OPENING.
 - AVERTISSEMENT - APRÈS MISE HORS TENSION, ATTENDRE 10 MINUTES AVANT L'OUVERTURE.
 - WARNING - POTENTIAL ELECTROSTATIC CHARGING HAZARD - SEE INSTRUCTIONS.
 - AVERTISSEMENT - DANGER POTENTIEL DE CHARGES ELECTROSTATIQUES - VOIR INSTRUCTIONS

9. THE TRANSMITTER IS NOT CAPABLE OF PASSING THE 500V ISOLATION TEST ON TERMINALS DUE TO INTEGRAL TRANSIENT PROTECTION. THIS MUST BE TAKEN INTO ACCOUNT UPON INSTALLATION.

10. THE ROSEMOUNT CABLING KITS, FOR INTRINSICALLY SAFE ELECTRODES, INCLUDE A CERTIFICATE OF CONFORMITY (COC) FROM THE MANUFACTURER FOR CAPACITANCE PER FOOT & INDUCTANCE PER FOOT. THESE PARAMETERS ARE ONLY REQUIRED FOR THE ENTITY CONCEPT METHOD OF INSTALLATION.

11. THE INTRINSICALLY SAFE ANALOG AND DIGITAL OUTPUTS MUST USE TWISTED PAIR WITH AN INDIVIDUAL SHIELD FOR THE PAIR. IT IS ALSO RECOMMENDED TO USE SHIELDED TWISTED PAIR FOR THE PULSE OUTPUT.

12. SEAL APPROVED FOR USE IN APPROPRIATE ZONE AND GAS GROUP.

13. TRANSMITTER OUTPUTS ARE CONSIDERED INTRINSICALLY SAFE WHEN INSTALLED IN ACCORDANCE TO INTRINSICALLY SAFE CONCEPTS AND INSTALLATION REQUIREMENTS WITHIN THIS DOCUMENT.

NOTES:

CONFIDENTIAL AND PROPRIETARY INFORMATION IS CONTAINED HEREIN AND MUST BE HANDLED ACCORDINGLY.	SURFACE FINISH UNLESS OTHERWISE SPECIFIED	125°	3RD ANGLE	SIZE	SCALE	REV
UNLESS OTHERWISE SPECIFIED DIMENSIONS IN INCHES (mm). REMOVE ALL BURRS AND SHARP EDGES.				C	-	AC
X ± .1 [2.5] .XX ± .02 [0.5] .XXX ± .010 [0.25] FRACTIONS ± 1/32 ANGLES ± 2°	EMERSON TITLE ROSEMOUNT INSTALLATION DRAWING 8750W, CSA CANADIAN AND USA ZONE					
DO NOT SCALE PRINT	CAD MAINTAINED, (PROVE)	PRODUCT CODE	DOC TYPE	SHEET 1	OF 11	

GAS ENVIRONMENT - EPL Gc SENSOR WITH ALLOWED INTEGRAL MOUNT EPL Gc TRANSMITTERS

Ex nA SENSOR INTEGRAL MOUNT CONFIGURATIONS

MODEL 8750WD INTEGRAL MOUNT CONFIGURATION WITH SAFETY APPROVAL OPTION 'ZC'

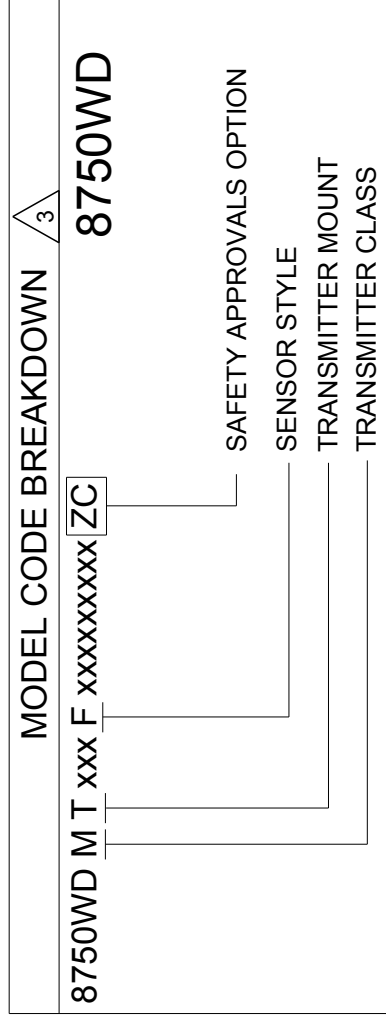

Ex nA ic IIC T5... T4 Gc
EPL Gc, FOR USE IN HAZARDOUS (EX) AREA - ZONE 2
WITH CARBON STEEL HOUSING (-29°C ≤ Ta ≤ 60°C)
SEE TABLE 1 FOR PROCESS TEMPERATURE LIMITS
AND ALLOWED MOUNTING CONFIGURATIONS
TYPE 'n' WITH INTRINSICALLY SAFE ELECTRODES

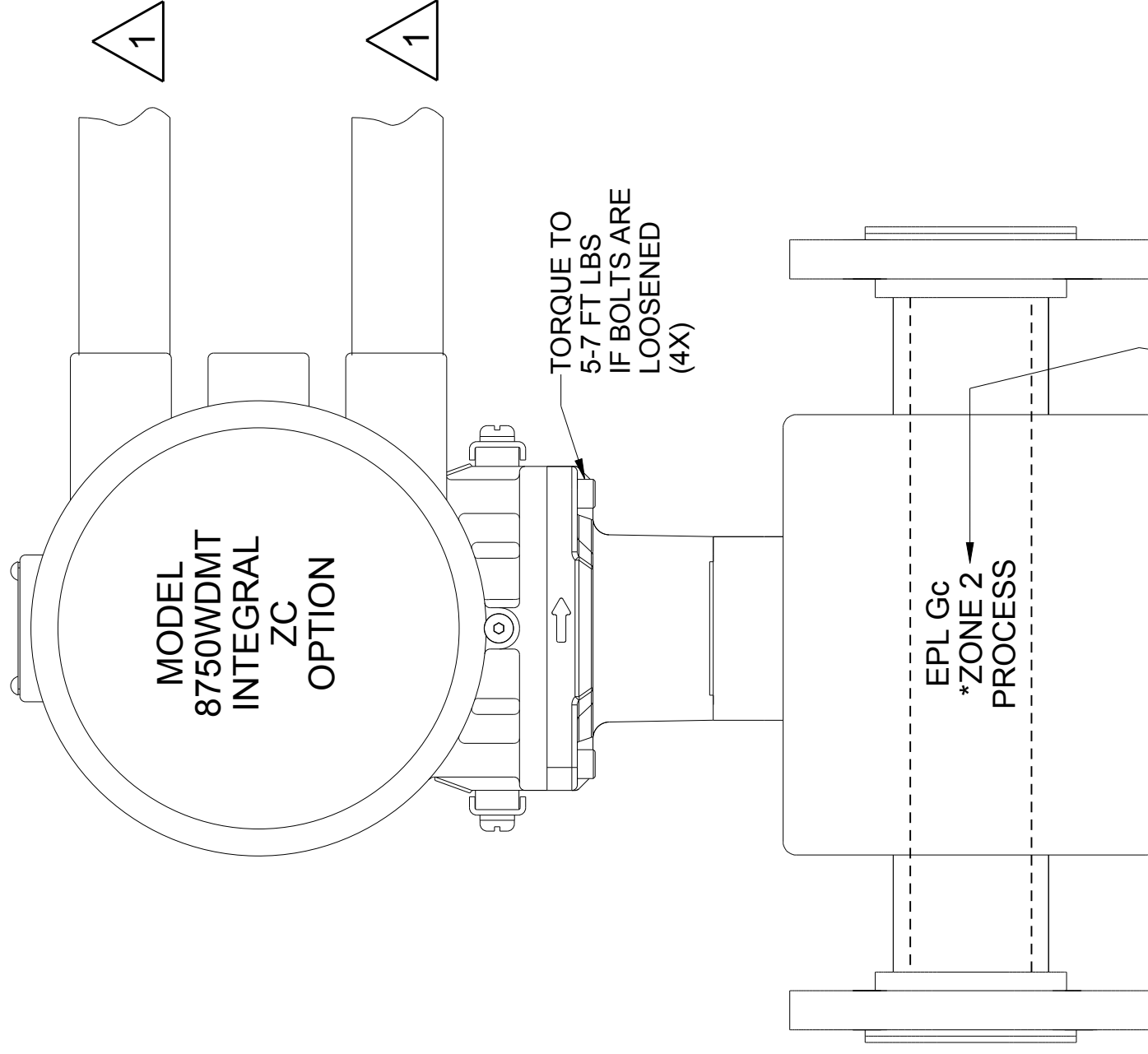

MODEL 8750WDMT INTEGRAL ZC OPTION

ELECTRODES CONTACT PROCESS

* TYPICAL APPLICATION: CONSULT LOCAL HAZARDOUS AREA (EX) ZONING FOR PROCESS FLUID CLASSIFICATION.

ALLOWED INTEGRAL MOUNT TRANSMITTER CONFIGURATIONS

MODEL 8750WD INTEGRAL MOUNT CONFIGURATION WITH SAFETY APPROVAL OPTION 'ZC'

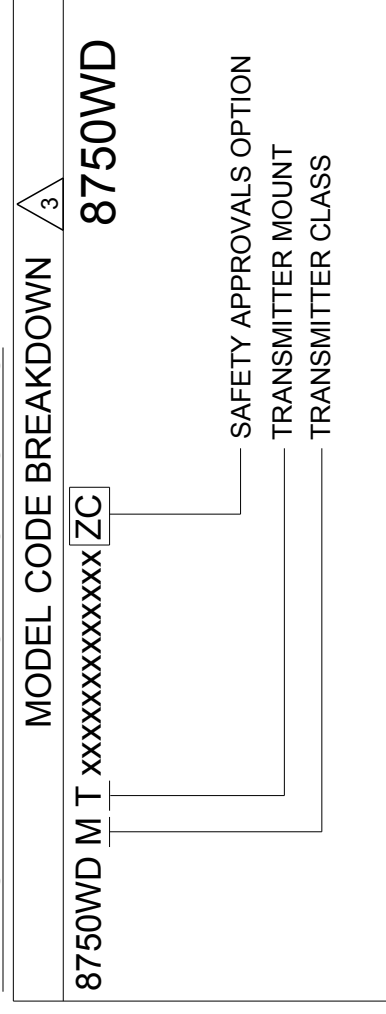

Ex nA [ic] IIC T4 Gc - DC POWER ONLY, IN PROTECTION TYPE 'n'
Ex ec [ic] IIC T4 Gc - DC POWER ONLY, IN PROTECTION TYPE 'e'
EPL Gc, FOR USE IN HAZARDOUS (EX) AREA - ZONE 2
SEE TABLE 1 FOR PROCESS TEMPERATURE LIMITS AND
ALLOWED MOUNTING CONFIGURATIONS

DRAWING NO. 8750W-2051

CONFIDENTIAL AND PROPRIETARY INFORMATION IS CONTAINED HEREIN AND MUST BE HANDLED ACCORDINGLY.	SURFACE FINISH UNLESS OTHERWISE SPECIFIED	125	3RD ANGLE		SIZE	C	SCALE	-	REV	AC
	EMERSON									
UNLESS OTHERWISE SPECIFIED DIMENSIONS IN INCHES (mm). REMOVE ALL BURRS AND SHARP EDGES.	TITLE									
-DEC TOLERANCES-	ROSEMOUNT									
X ± .1 [2.5]	INSTALLATION DRAWING 8750W,									
.XX ± .02 [0.5]	CSA CANADIAN AND USA ZONE									
.XXX ± .010 [0.25]	DR. J. LAGE 9/16/15 DRAWING NO. 8750W-2051									
FRACTIONS ± 1/32	APPD. M. MAYER 9/16/15 PRODUCT CODE									
ANGLES ± 2'	DO NOT SCALE PRINT CAD MAINTAINED (PROVE) SHEET 2 OF 11									

GAS ENVIRONMENT - EPL Gc SENSOR WITH ALLOWED REMOTE MOUNT EPL Gc TRANSMITTERS

Ex nA SENSOR REMOTE MOUNT CONFIGURATIONS

MODEL 8750WD REMOTE MOUNT SENSOR CONFIGURATION
WITH SAFETY APPROVAL OPTION 'ZC'

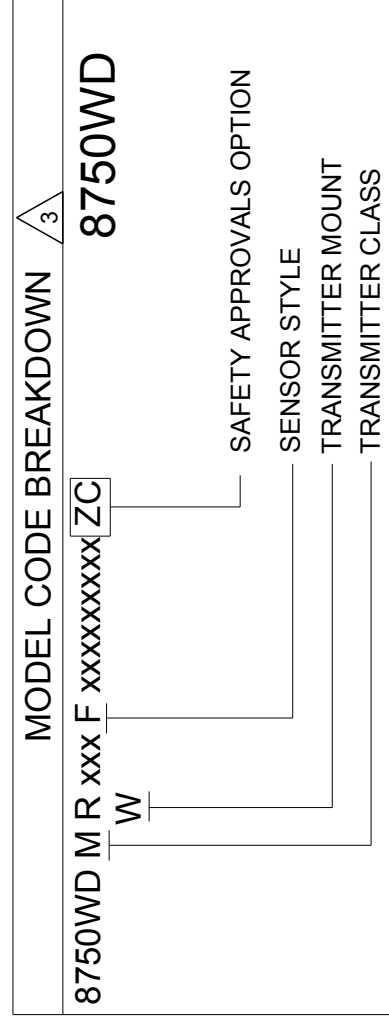

Ex nA ic IIC T5...T4 Gc
EPL Gc. FOR USE IN HAZARDOUS (Ex) AREA - ZONE 2
WITH CARBON STEEL HOUSING (-29°C ≤ Ta ≤ 60°C)
SEE TABLE 1 FOR PROCESS TEMPERATURE LIMITS
AND ALLOWED MOUNTING CONFIGURATIONS
TYPE 'n' WITH INTRINSICALLY SAFE ELECTRODES

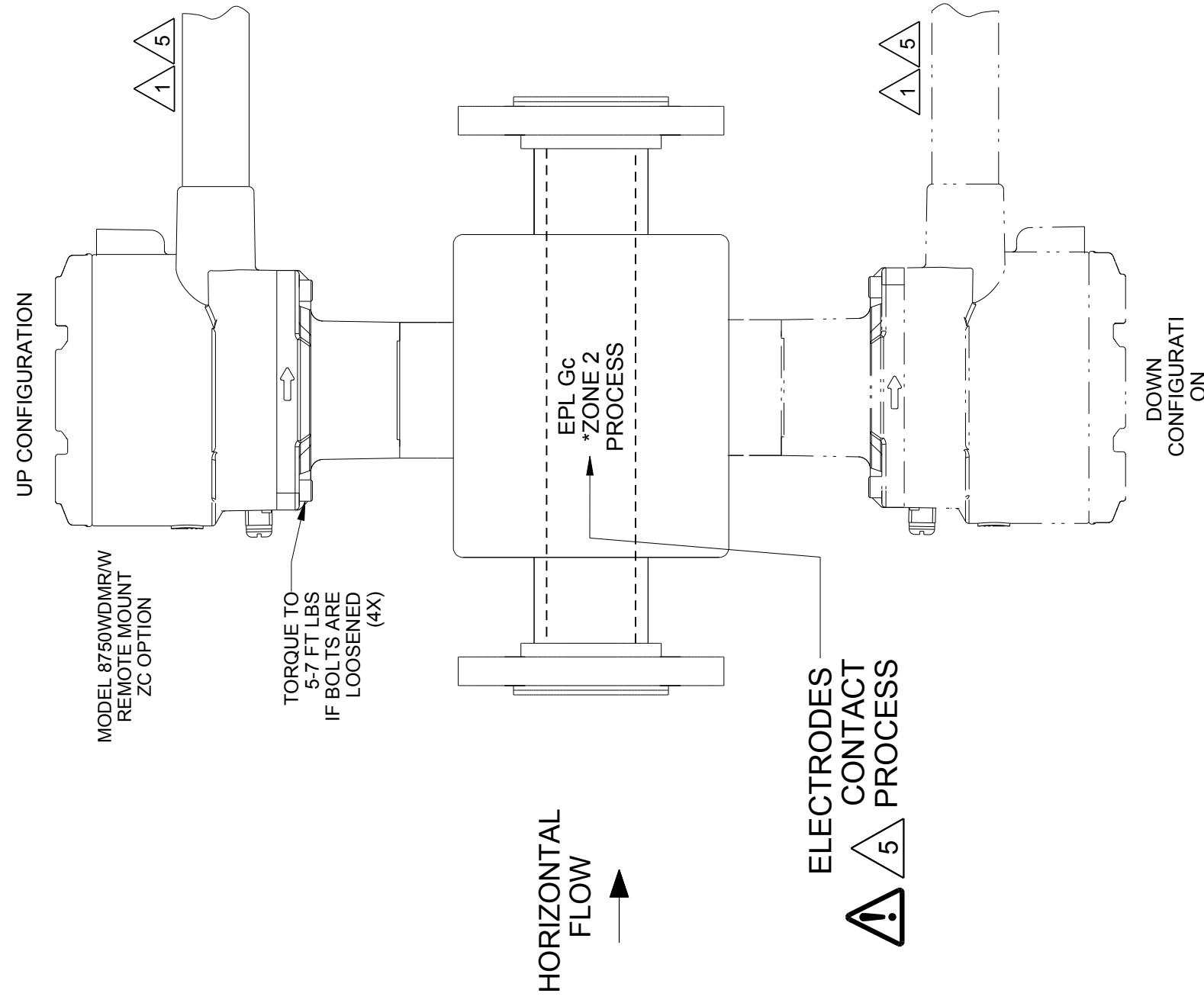

ALLOWED REMOTE MOUNT TRANSMITTER CONFIGURATIONS

MODEL 8750WD REMOTE FIELD MOUNT CONFIGURATION
WITH SAFETY APPROVAL OPTION 'ZC'

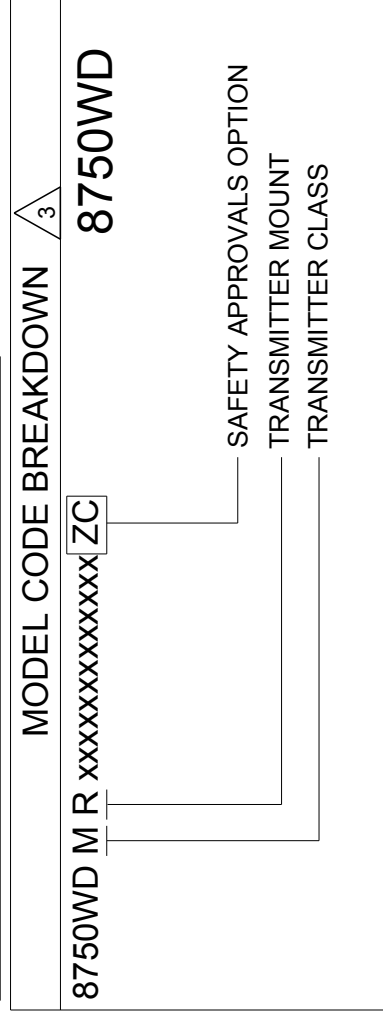

Ex nA [ic] IIC T4 Gc - DC POWER ONLY, IN PROTECTION TYPE 'n'
Ex ec [ic] IIC T4 Gc - DC POWER ONLY, IN PROTECTION TYPE 'e'
EPL Gc. FOR USE IN HAZARDOUS (Ex) AREA - ZONE 2
TEMPERATURE CLASS: EPL Gc: T4 (-40°C ≤ Ta ≤ 60°C)
WITH INTRINSICALLY SAFE ELECTRODE CIRCUIT

MODEL 8750WD REMOTE WALLMOUNT CONFIGURATION
WITH SAFETY APPROVAL OPTION 'ZC'

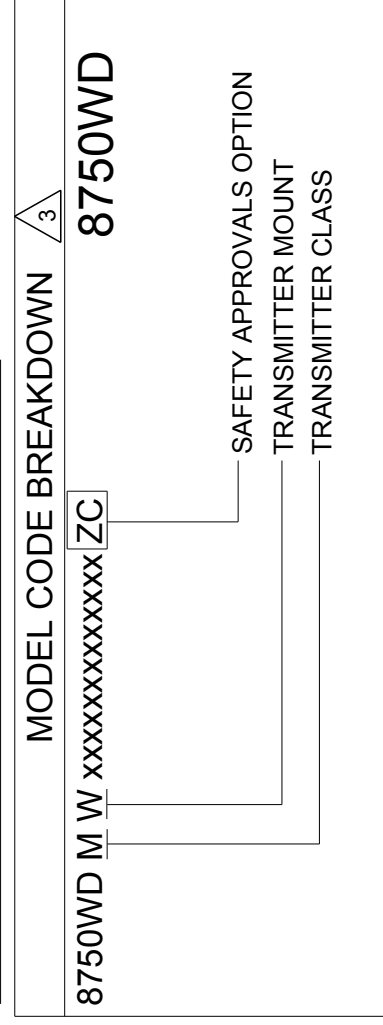

Ex nA [ic] IIC T4 Gc - DC POWER ONLY, IN PROTECTION TYPE 'n'
Ex ec [ic] IIC T4 Gc - DC POWER ONLY, IN PROTECTION TYPE 'e'
EPL Gc. FOR USE IN HAZARDOUS (Ex) AREA - ZONE 2
TEMPERATURE CLASS: EPL Gc: T4 (-40°C ≤ Ta ≤ 60°C)
WITH INTRINSICALLY SAFE ELECTRODE CIRCUIT

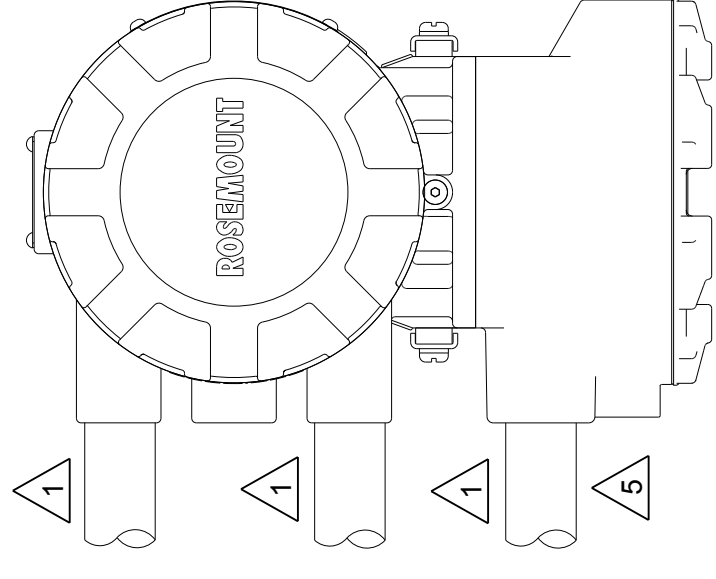

MODEL 8750WDMR
REMOTE MOUNT
ZC OPTION

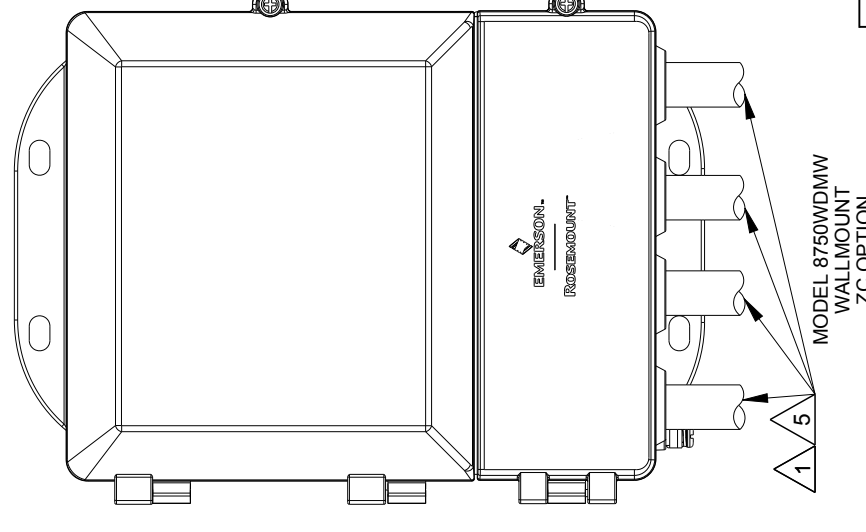

MODEL 8750WDMW
WALL MOUNT
ZC OPTION

8750W-2051

DRAWING NO.

CONFIDENTIAL AND PROPRIETARY INFORMATION IS CONTAINED HEREIN AND MUST BE HANDLED ACCORDINGLY.	SURFACE FINISH UNLESS OTHERWISE SPECIFIED	125	3RD ANGLE	SIZE	C	SCALE	-	REV	AC
UNLESS OTHERWISE SPECIFIED DIMENSIONS IN INCHES (mm). REMOVE ALL BURRS AND SHARP EDGES.	EMERSON								
-DEC TOLERANCES-	ROSEMOUNT								
X ± .1 [2.5]	TITLE								
.XX ± .02 [0.5]	INSTALLATION DRAWING 8750W,								
.XXX ± .010 [0.25]	CSA CANADIAN AND USA ZONE								
FRACTIONS ± 1/32	DR. J. LAGE 9/16/15 DRAWING NO. 8750W-2051								
ANGLES ± 2°	APPD. M. MAYER 9/16/15								
DO NOT SCALE PRINT	CAD MAINTAINED. (PROE) PRODUCT CODE SHEET 3 OF 11								

* TYPICAL APPLICATION. CONSULT LOCAL HAZARDOUS AREA (Ex) ZONING FOR PROCESS FLUID CLASSIFICATION.

DUST ENVIRONMENT - EPL Dc SENSOR WITH ALLOWED INTEGRAL MOUNT EPL Dc TRANSMITTERS

Ex tc SENSOR INTEGRAL MOUNT CONFIGURATIONS

MODEL 8750WD INTEGRAL MOUNT CONFIGURATION WITH SAFETY APPROVAL OPTION 'ZC'

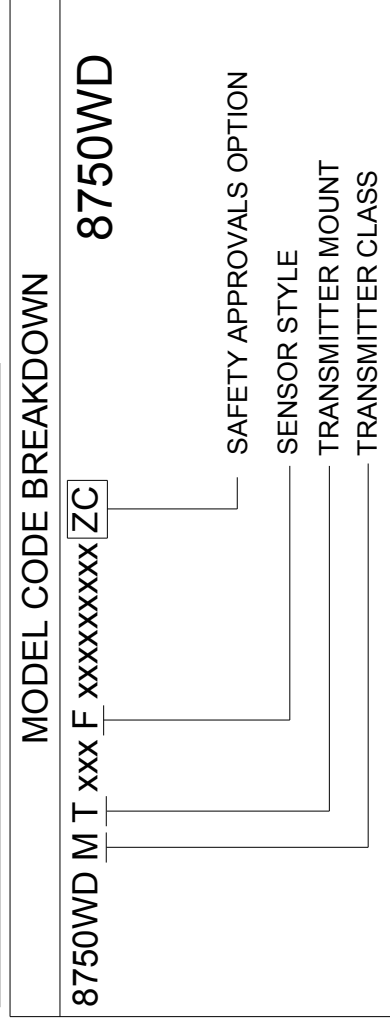

Ex tc IIIC T80°C...T130°C Dc EPL Dc, FOR USE IN ZONE 22 WITH CARBON STEEL HOUSING (-29°C ≤ Ta ≤ 60°C) SEE TABLE 2 FOR PROCESS TEMPERATURE LIMITS AND ALLOWED MOUNTING CONFIGURATION

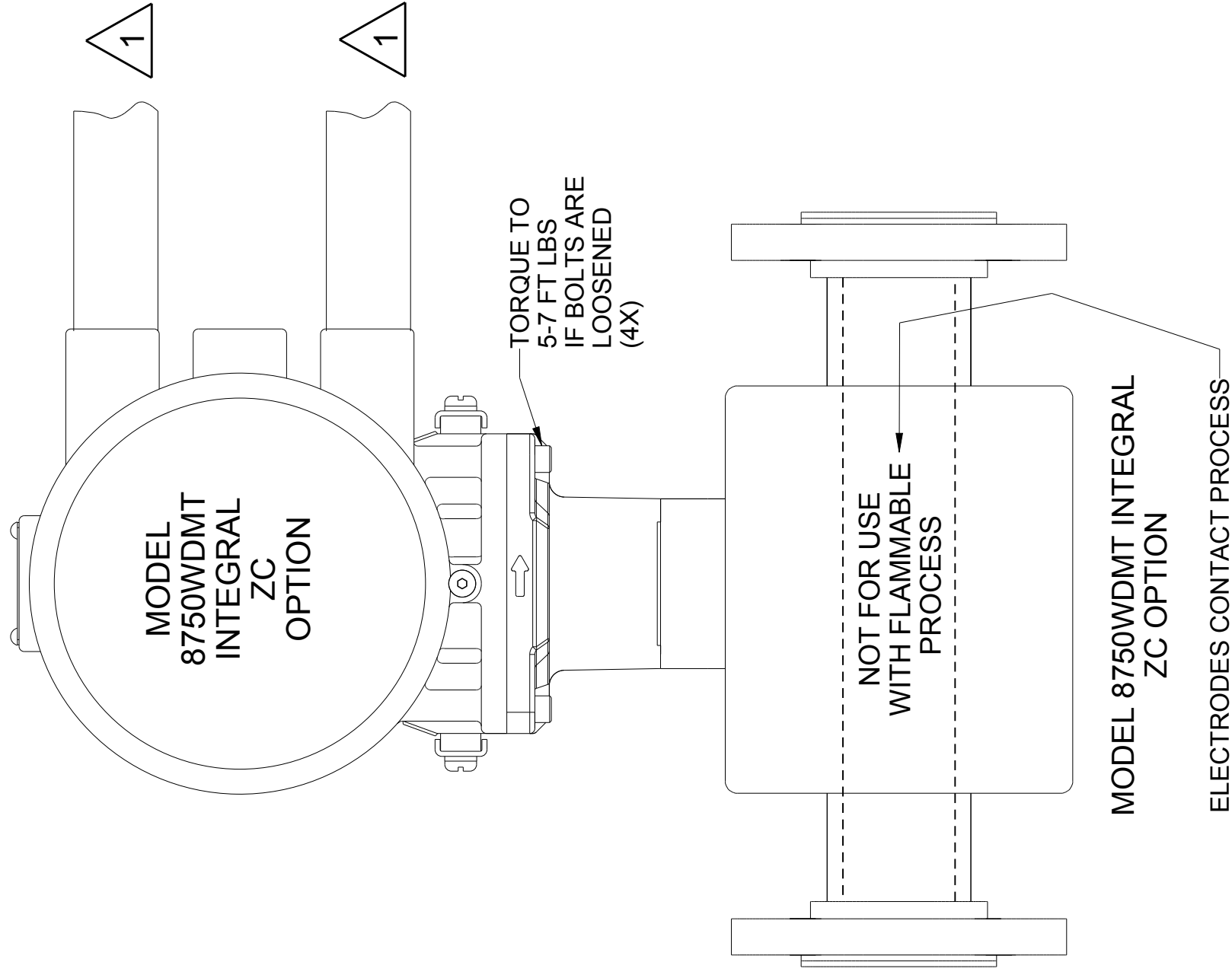

ALLOWED INTEGRAL MOUNT TRANSMITTER CONFIGURATIONS

MODEL 8750WD INTEGRAL MOUNT CONFIGURATION WITH SAFETY APPROVAL OPTION 'ZC'

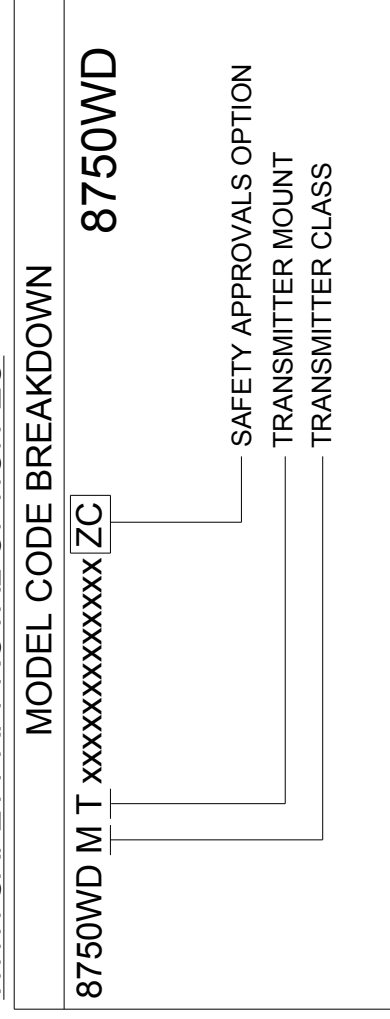

Ex tc IIIC T80°C...T130°C Dc EPL Dc, FOR USE IN ZONE 22 SEE TABLE 2 FOR TEMPERATURE CLASS AND SPECIFIED MAXIMUM SURFACE TEMPERATURE "T" OF FLOWTUBES ON WHICH THE TRANSMITTER IS MOUNTED

1	2	3	4	5	6	7	8	9	10	11	12
A	A										
B	B										
C	C										
D	D										
E	E										
F	F										
G	G										
H	H										

8750W-2051
DRAWING NO.

CONFIDENTIAL AND PROPRIETARY INFORMATION IS CONTAINED HEREIN AND MUST BE HANDLED ACCORDINGLY.	SURFACE FINISH UNLESS OTHERWISE SPECIFIED	125	3RD ANGLE	SIZE	C	SCALE	-	REV	AC
UNLESS OTHERWISE SPECIFIED DIMENSIONS IN INCHES (mm). REMOVE ALL BURRS AND SHARP EDGES.	EMERSON								
-DEC TOLERANCES- X ± .1 [2.5] .XX ± .02 [0.5] .XXX ± .010 [0.25] FRACTIONS ± 1/32 ANGLES ± 2°	ROSEMOUNT								
TITLE INSTALLATION DRAWING 8750W, CSA CANADIAN AND USA ZONE									
DR. J. LAGE	9/16/15	DRAWING NO.		8750W-2051					
APPD. M. MAYER	9/16/15	PRODUCT CODE		SHEET 4 OF 11					
DO NOT SCALE PRINT CAD MAINTAINED. (PROJ)									

DUST ENVIRONMENT - EPL Dc SENSOR WITH ALLOWED REMOTE MOUNT EPL Dc TRANSMITTERS

Ex tc SENSOR REMOTE MOUNT CONFIGURATIONS

MODEL 8750WD REMOTE MOUNT SENSOR CONFIGURATION
WITH SAFETY APPROVAL OPTION 'ZC'

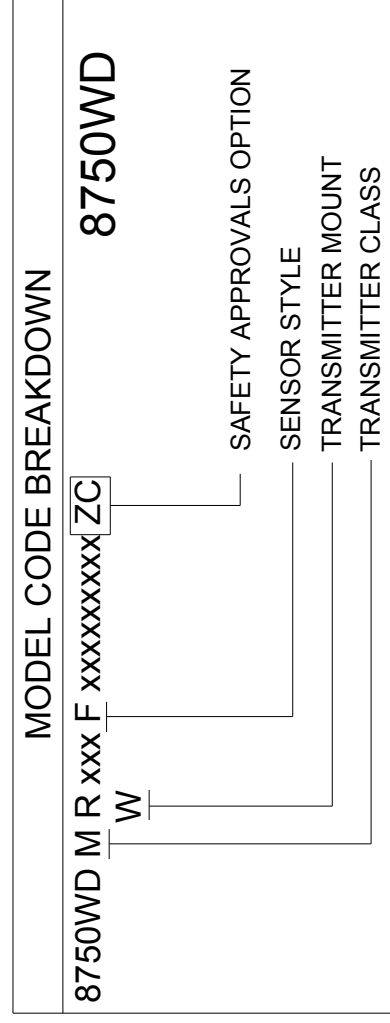

Ex tc IIIC T80°C...T130°C Dc
EPL Dc, FOR USE IN ZONE 22
WITH CARBON STEEL HOUSING (-29°C ≤ Ta ≤ 60°C)
SEE TABLE 2 FOR PROCESS TEMPERATURE LIMITS
AND ALLOWED MOUNTING CONFIGURATION

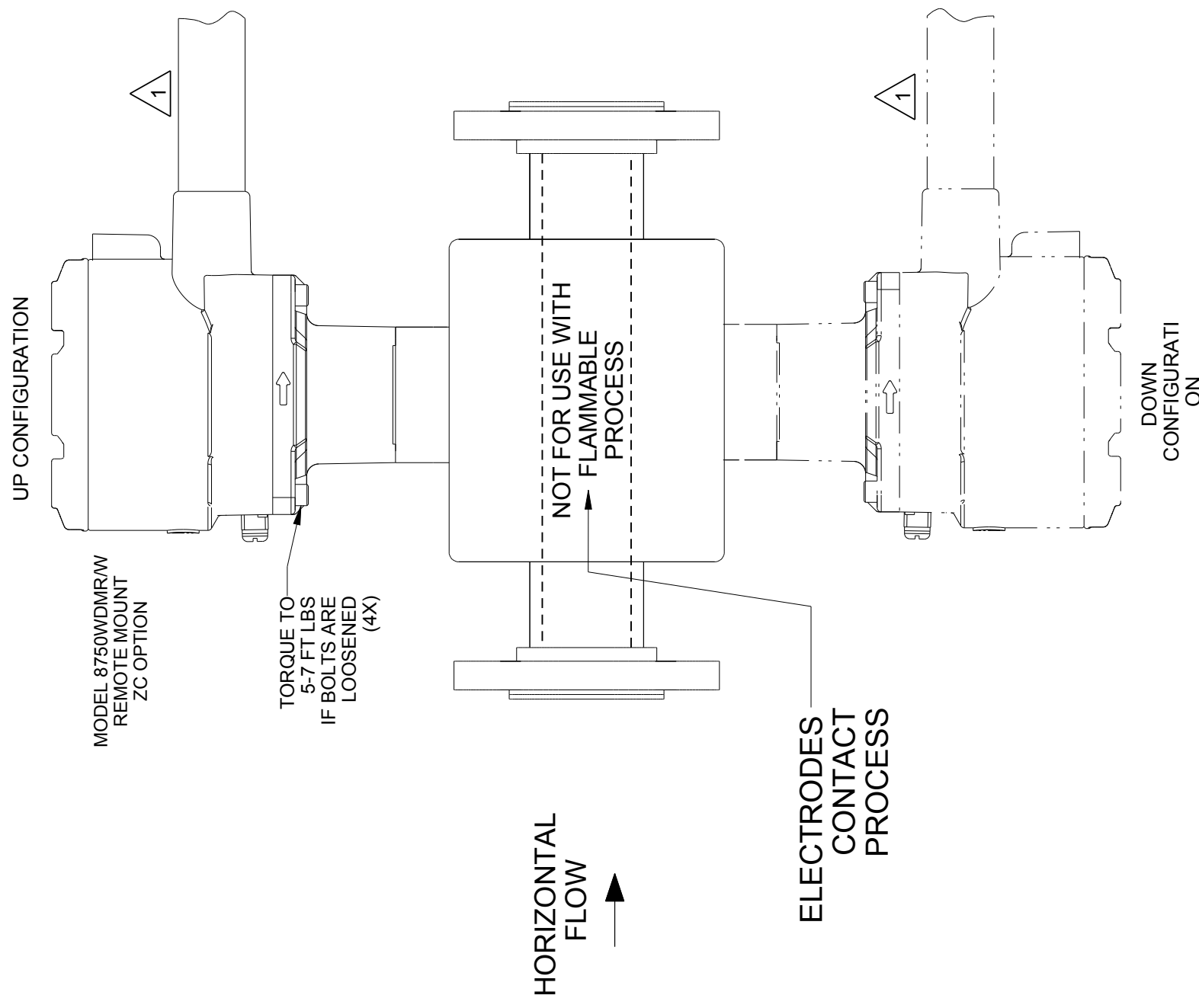

ALLOWED REMOTE MOUNT TRANSMITTER CONFIGURATIONS

MODEL 8750WD REMOTE MOUNT CONFIGURATION
WITH SAFETY APPROVAL OPTION 'ZC'

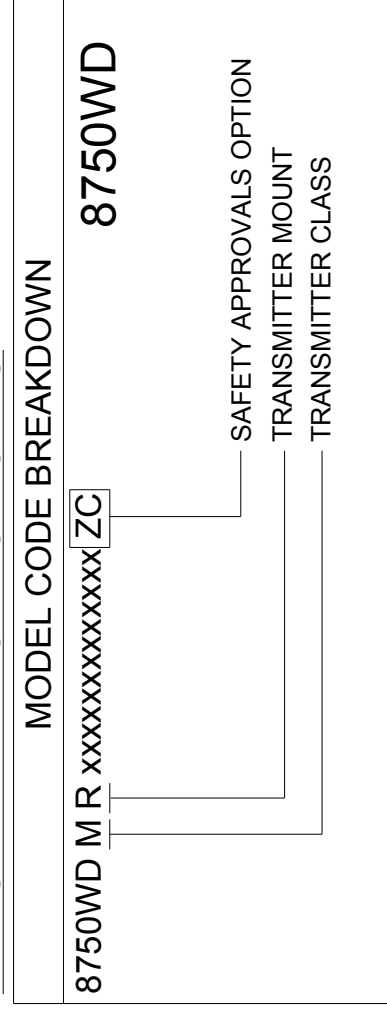

Ex tc IIIC T80°C...T130°C Dc
EPL Dc, FOR USE IN ZONE 22
REMOTE FIELD MOUNT TRANSMITTER MAXIMUM SURFACE
TEMPERATURE T80°C (-40°C ≤ Ta ≤ 60°C)

MODEL 8750WD REMOTE WALL MOUNT CONFIGURATION
WITH SAFETY APPROVAL OPTION 'ZC'

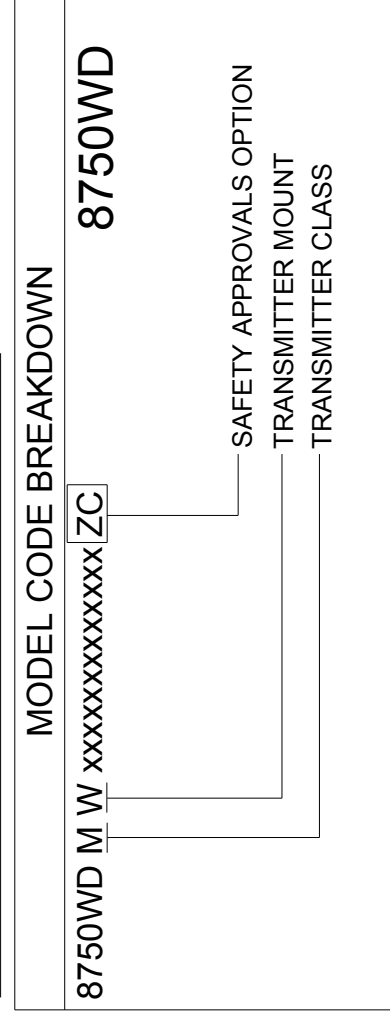

Ex tc IIIC T80°C Dc
EPL Dc, FOR USE IN ZONE 22
REMOTE WALL MOUNT TRANSMITTER MAXIMUM SURFACE
TEMPERATURE T80°C (-40°C ≤ Ta ≤ 60°C)

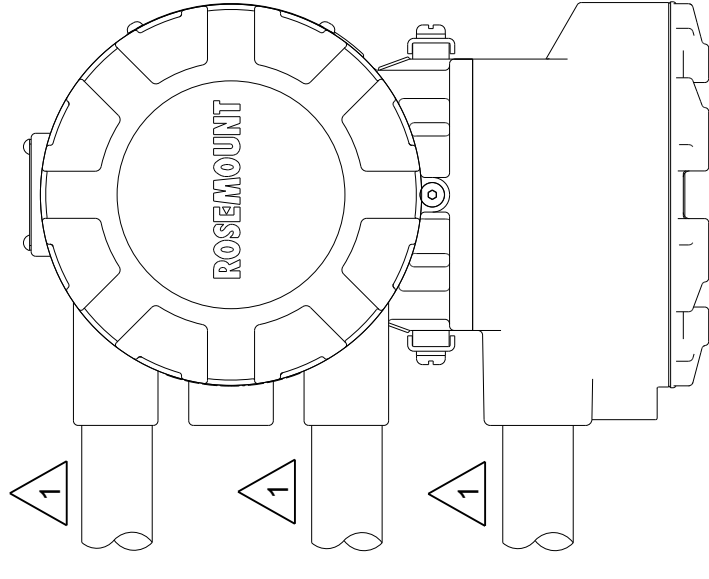

MODEL 8750WDMR
REMOTE MOUNT
ZC OPTION

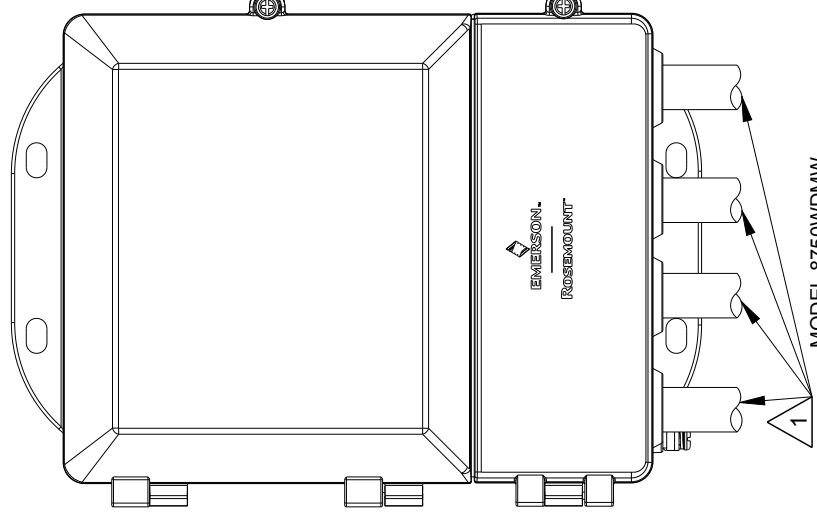

MODEL 8750WDMW
WALL MOUNT
ZC OPTION

CONFIDENTIAL AND PROPRIETARY INFORMATION IS CONTAINED HEREIN AND MUST BE HANDLED ACCORDINGLY.	SURFACE FINISH UNLESS OTHERWISE SPECIFIED	125	3RD ANGLE	SIZE	C	SCALE	-	REV	AC
UNLESS OTHERWISE SPECIFIED DIMENSIONS IN INCHES (mm). REMOVE ALL BURRS AND SHARP EDGES.	ROSEMOUNT								
-DEC TOLERANCES- X ± .1 [2.5] .XX ± .02 [0.5] .XXX ± .010 [0.25] FRACTIONS ± 1/32 ANGLES ± 2°	EMERSON INSTALLATION DRAWING 8750W, CSA CANADIAN AND USA ZONE								
DO NOT SCALE PRINT CAD MAINTAINED, (PROE) PRODUCT CODE	DR. J. LAGE 9/16/15		DRAWING NO. 8750W-2051		DOC TYPE SHEET 5		OF 11		
APPD M. MAYER 9/16/15		TITLE		ROSEMOUNT		DRAWING NO.		8750W-2051	

GAS AND DUST ENVIRONMENT - EPL Gc AND EPL Dc - SENSOR TEMPERATURE CODE VS. PROCESS TEMPERATURE AND INGRESS PROTECTION RATINGS

**TABLE 1 - 8750W: Ex nA PROTECTION TYPE 'n'
SAFETY APPROVAL OPTION 'ZC'
ALLOWED TRANSMITTER MOUNTING AND TEMPERATURE CODE VS. PROCESS TEMPERATURE**

LINE SIZE	MAXIMUM PROCESS TEMPERATURE (°C)	T CLASSIFICATION CODE	MOUNTING CONFIGURATION
ALL	60	T4	SENSOR WITH INTEGRAL MOUNT TRANSMITTER
ALL	90	T4	SENSOR WITH INTEGRAL MOUNT TRANSMITTER
ALL	60	T5	REMOTE SENSOR WITH REMOTE JUNCTION BOX (RJB)
ALL	90	T4	REMOTE SENSOR WITH REMOTE JUNCTION BOX (RJB)
ALL	120	T4	REMOTE SENSOR WITH REMOTE JUNCTION BOX (RJB)
ALL	NOT APPLICABLE	T4	REMOTE FIELD MOUNT TRANSMITTER
ALL	NOT APPLICABLE	T4	REMOTE WALLMOUNT TRANSMITTER

**TABLE 2 - 8750W: Ex tc PROTECTION TYPE 't'
SAFETY APPROVAL OPTION 'ZC'
ALLOWED TRANSMITTER MOUNTING AND TEMPERATURE CODE VS. PROCESS TEMPERATURE**

LINE SIZE	MAXIMUM PROCESS TEMPERATURE (°C)	MAXIMUM SURFACE TEMPERATURE	MOUNTING CONFIGURATION
ALL	60	T 80°C	SENSOR WITH INTEGRAL MOUNT TRANSMITTER
ALL	90	T 100°C	SENSOR WITH INTEGRAL MOUNT TRANSMITTER
ALL	60	T 80°C	REMOTE SENSOR WITH REMOTE JUNCTION BOX (RJB)
ALL	90	T 100°C	REMOTE SENSOR WITH REMOTE JUNCTION BOX (RJB)
ALL	120	T 130°C	REMOTE SENSOR WITH REMOTE JUNCTION BOX (RJB)
ALL	NOT APPLICABLE	T 80°C	REMOTE FIELD MOUNT TRANSMITTER
ALL	NOT APPLICABLE	T 80°C	REMOTE WALLMOUNT TRANSMITTER

**TABLE 3 - 8750W: INGRESS PROTECTION AND CORROSION PROTECTION RATINGS
SAFETY APPROVAL OPTION 'ZC'
ALLOWED TRANSMITTER MOUNTING AND PROTECTION RATINGS**

LINE SIZE	IP RATING	NEMA RATING	MOUNTING CONFIGURATION
ALL	IP66	TYPE 4X	SENSOR WITH INTEGRAL MOUNT TRANSMITTER
ALL	IP66	TYPE 4X	REMOTE FIELD MOUNT TRANSMITTER
ALL	IP66	TYPE 4X	REMOTE WALLMOUNT TRANSMITTER
ALL	IP66, IP68* or IP69K	TYPE 4X	REMOTE SENSOR WITH REMOTE JUNCTION BOX (RJB)

* IP x8 submergence depth is 10 meters (30 feet) for 48 hours duration

CONFIDENTIAL AND PROPRIETARY INFORMATION IS CONTAINED HEREIN AND MUST BE HANDLED ACCORDINGLY.

UNLESS OTHERWISE SPECIFIED DIMENSIONS IN INCHES (mm). REMOVE ALL BURRS AND SHARP EDGES.

-DEC TOLERANCES-
 X ± .1 [2.5]
 .XX ± .02 [0.5]
 .XXX ± .010 [0.25]
 FRACTIONS ANGLES
 ± 1/32 ± 2°



TITLE
**INSTALLATION DRAWING 8750W,
 CSA CANADIAN AND USA ZONE**

DR. J. LAGE 9/16/15 DRAWING NO. 8750W-2051
 APPD. M. MAYER 9/16/15

ROSEMOUNT

SURFACE FINISH UNLESS OTHERWISE SPECIFIED
 125°
 3RD ANGLE
 SIZE C
 SCALE 1:1
 REV AC
 DRAWING NO. 8750W-2051

GAS ENVIRONMENT- EPL Gc COIL AND ELECTRODE CIRCUIT WIRING

MODEL 8750WD WITH INTRINSICALLY SAFE ELECTRODE CIRCUIT FOR USE WITH SAFETY APPROVAL OPTION ZC

DIVIDER REQUIRED FOR INTRINSIC SAFETY (Ex i)
 COMPONENT CABLES ONLY. SEE TABLE BELOW FOR COMPATIBLE WIRING. SEE INSTALLATION WIRING DRAWING 08732-1504 FOR CABLING DETAILS. (FOR PROCESS TEMPERATURE LIMITS SEE TABLE 1)

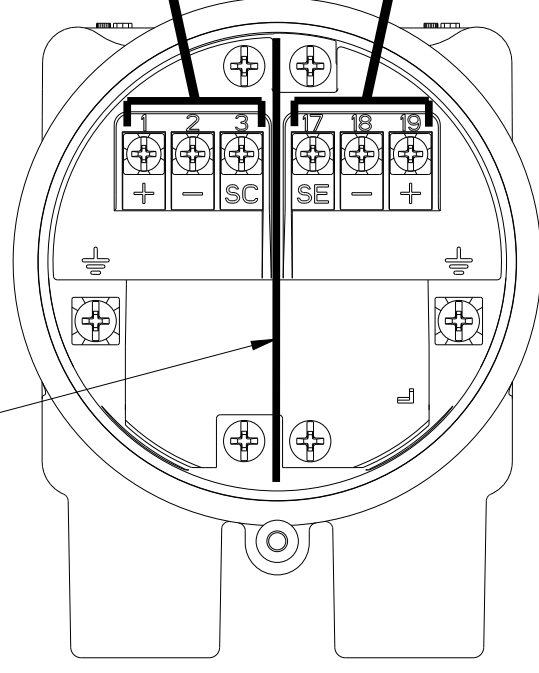

8750WDMR/W FLOWTUBE REMOTE JUNCTION BOX

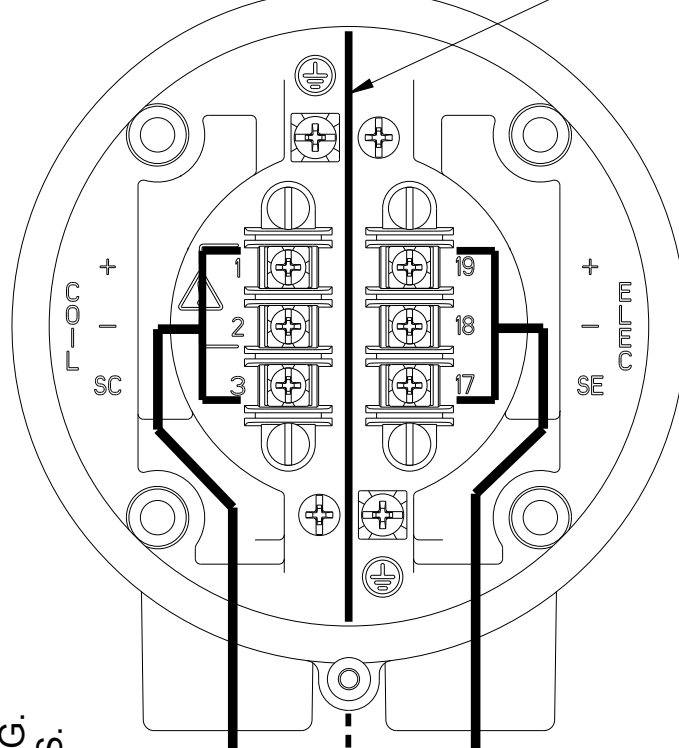

8750WDMR TRANSMITTER REMOTE JUNCTION BOX

MODEL 8750WD WITH INTRINSICALLY SAFE ELECTRODE CIRCUIT FOR USE WITH SAFETY APPROVAL OPTION ZC

DIVIDER REQUIRED FOR INTRINSIC SAFETY (Ex i)
 COMPONENT CABLES ONLY. SEE TABLE BELOW FOR COMPATIBLE WIRING. SEE INSTALLATION WIRING DRAWING 08712-1504 FOR CABLING DETAILS. (FOR PROCESS TEMPERATURE LIMITS SEE TABLE 1)

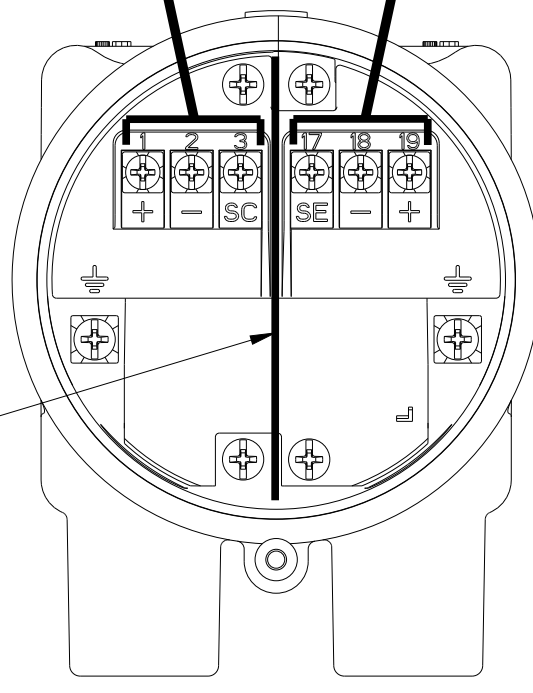

8750WDMR/W FLOWTUBE REMOTE JUNCTION BOX

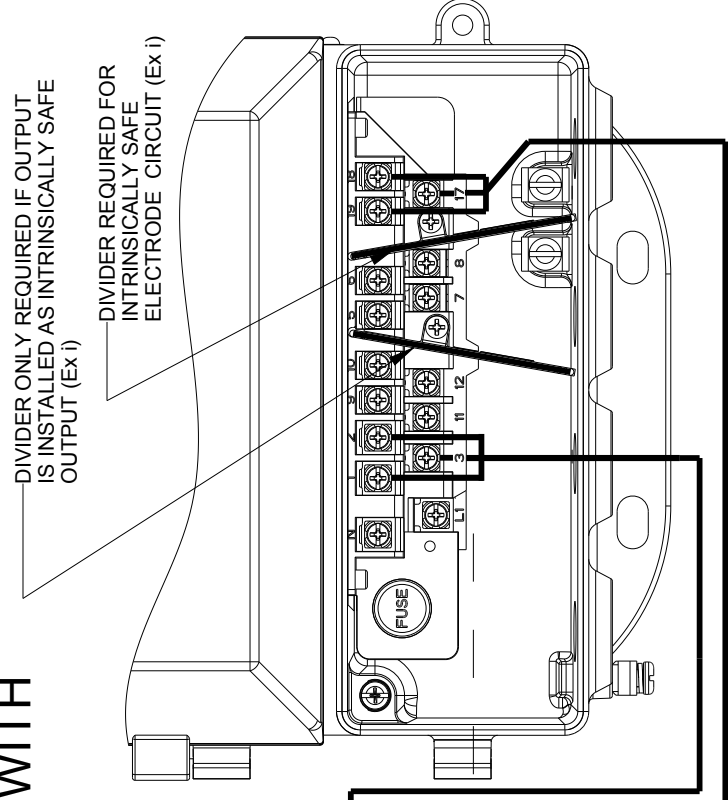

8750WDMW TRANSMITTER (LOWER COVER AND SAFETY COVER ARE NOT SHOWN)

SYSTEM APPROVAL FOR INTRINSICALLY SAFE ELECTRODE INSTALLATION

THE MODEL 8750WD MAGNETIC FLOWMETER REFERENCING CONTROL DRAWING 8750W-2051 MAY USE UP TO 500 FEET (150 METERS) OF ROSEMOUNT SUPPLIED ELECTRODE CABLING FOR INTERCONNECTION OF THE DEVICES. THE CORRECT CABLING IS SUPPLIED AS PART OF THE FOLLOWING ROSEMOUNT CABLING KITS:

COIL AND INTRINSICALLY SAFE ELECTRODE COMPONENT CABLES:

ROSEMOUNT PART NO.	UNIT OF MEASURE	TEMPERATURE RANGE	SEE NOTE
08732-0065-0003	FEET	-20° C TO 75° C	10
08732-0065-0004	METERS	-20° C TO 75° C	
08732-0065-1003	FEET	-50° C TO 125° C	
08732-0065-1004	METERS	-50° C TO 125° C	

INDIVIDUAL OR REPLACEMENT INTRINSICALLY SAFE ELECTRODE COMPONENT CABLES:

ROSEMOUNT PART NO.	UNIT OF MEASURE	TEMPERATURE RANGE	SEE NOTE
08732-0061-0003	FEET	-20° C TO 75° C	10
08732-0061-0004	METERS	-20° C TO 75° C	
08732-0061-1003	FEET	-50° C TO 125° C	
08732-0061-1004	METERS	-50° C TO 125° C	

TERMINALS 19, 18, AND 17 CONTAIN TWO CHANNELS OF AN INTRINSICALLY SAFE CIRCUIT WITH A COMMON RETURN. ENTITY PARAMETERS SHOWN BELOW ARE THE SUMMATION OF BOTH CHANNELS.

TRANSMITTER ENTITY PARAMETERS
 MODEL: 8750WDMT, 8750WDMR, AND 8750WDMW
 INTRINSICALLY SAFE ELECTRODE CIRCUIT
 REMOTE JUNCTION BOX TERMINALS 19, 18, 17
 $U_0 = 28.56V$
 $I_0 = 5.77mA$
 $P_0 = 165mW$
 $C_0 = 61.7nF$
 $L_0 = 1.0H$

FLOW TUBE ENTITY PARAMETERS
 MODEL: 8750WDMxxxxF
 INTRINSICALLY SAFE ELECTRODE CIRCUIT
 REMOTE JUNCTION BOX TERMINALS 19, 18, 17
 $U_i = 30V$
 $I_i = 50mA$
 $P_i = 1.0W$
 $C_i = 1.9nF$
 $L_i = 630\mu H$

THE ENTITY CONCEPT ALLOWS INTERCONNECTION OF ASSOCIATED APPARATUS AND INTRINSICALLY SAFE APPARATUS WHEN THE FOLLOWING IS TRUE:

$U_0 \leq U_i$, $I_0 \leq I_i$, $P_0 \leq P_i$, $C_0 \geq C_i + C_{cable}$, $L_0 \geq L_i + L_{cable}$
 THE ALLOWED CAPACITANCE, C_0 IS SHARED BETWEEN THE CIRCUITS OF TERMINALS 19, 18, AND 17. CABLE CAPACITANCE MUST BE ASSESSED AS TWICE THE MEASURED VALUE PER LENGTH OF CABLE.

EXAMPLE 1: THE HIGHEST MEASURED CAPACITANCE OF A 3 CONDUCTOR, SHIELDED CABLE IS 58pF/ft WHEN MEASURED CONDUCTOR TO CONDUCTOR TIED TO SHIELD.

$C_{cable} = 2 \times 58pF/ft \times \text{FEET OF CABLE}$
 $C_i + C_{cable} < C_0$
 CABLE LENGTH MUST BE UNDER 515 FEET

ENTITY CONCEPT FOR INTRINSICALLY SAFE ELECTRODE INSTALLATION

TERMINAL	LABEL
19	ELECTRODE +
18	ELECTRODE -
17	ELECTRODE REFERENCE (SE)
1	NON-INTRINSICALLY SAFE COIL CIRCUIT
2	COIL +
3	COIL -
	COIL SHIELD (SC)

TERMINAL	LABEL
19	INTRINSICALLY SAFE ELECTRODE CIRCUIT
18	ELECTRODE +
17	ELECTRODE -
	ELECTRODE REFERENCE (SE)
1	NON-INTRINSICALLY SAFE COIL CIRCUIT
2	COIL +
3	COIL -
	COIL SHIELD (SC)

DIVIDER REQUIRED FOR INTRINSIC SAFETY (Ex i)

DIVIDER ONLY REQUIRED IF OUTPUT IS INSTALLED AS INTRINSICALLY SAFE OUTPUT (Ex i)

DIVIDER REQUIRED FOR INTRINSICALLY SAFE ELECTRODE CIRCUIT (Ex i)

CONFIDENTIAL AND PROPRIETARY INFORMATION IS CONTAINED HEREIN AND MUST BE HANDLED ACCORDINGLY.

UNLESS OTHERWISE SPECIFIED DIMENSIONS IN INCHES (mm). REMOVE ALL BURRS AND SHARP EDGES.

-DEC TOLERANCES-	ANGLES
X ± .1 (2.5)	± 2°
.XX ± .02 (0.5)	
.XXX ± .010 (0.25)	
FRACTIONS ± 1/32	



TITLE
 INSTALLATION DRAWING 8750W,
 CSA CANADIAN AND USA ZONE

DR. J. LAGE 9/16/15 DRAWING NO.
 APPD. M. MAYER 9/16/15

DO NOT SCALE PRINT | CAD MAINTAINED: (PROJ) | PRODUCT CODE | SHEET 7 OF 11

REVISIONS
 SURFACE FINISH UNLESS OTHERWISE SPECIFIED
 125°
 3RD ANGLE
 SCALE
 SIZE
 C

ROSEMOUNT

DRAWING NO.
 8750W-2051

DUST ENVIRONMENT - EPL Dc COIL AND ELECTRODE CIRCUIT WIRING

MODEL 8750WD WITH NON-INTRINSICALLY SAFE ELECTRODE CIRCUIT
 FOR USE WITH SAFETY APPROVAL OPTION ZC
 COMPONENT OR COMBINATION COIL/ELECTRODE CABLE ALLOWED.
 SEE INSTALLATION WIRING DRAWING 08732-1504 FOR NON-INTRINSICALLY SAFE CABLING
 (FOR PROCESS TEMPERATURE LIMITS SEE TABLE 2)

OPTIONAL DIVIDER SHOWN

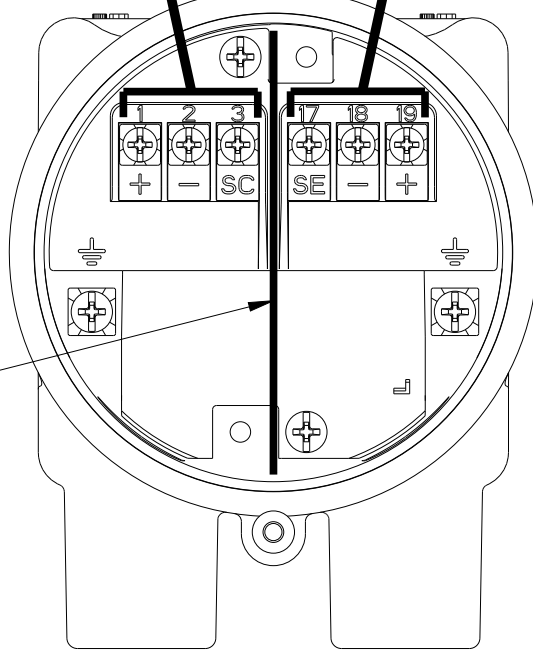

NON-INTRINSICALLY SAFE COIL CIRCUIT
 INSTALL USING EPL Dc WIRING
 METHODS APPROPRIATE TO THE AREA DEVICE
 IS INSTALLED IN

FOR USE WITH NON-FLAMMABLE PROCESS ONLY.
 INSTALL ELECTRODE CIRCUIT AS NON-INTRINSICALLY SAFE
 USING EPL Dc WIRING METHODS APPROPRIATE
 TO THE AREA DEVICE IS INSTALLED IN.

8750WDMR/W FLOWTUBE
 REMOTE JUNCTION BOX

TERMINAL	LABEL
NON-INTRINSICALLY SAFE ELECTRODE CIRCUIT	
19	ELECTRODE +
18	ELECTRODE -
17	ELECTRODE REFERENCE (SE)
NON-INTRINSICALLY SAFE COIL CIRCUIT	
1	COIL +
2	COIL -
3	COIL SHIELD (SC)

OPTIONAL DIVIDER SHOWN

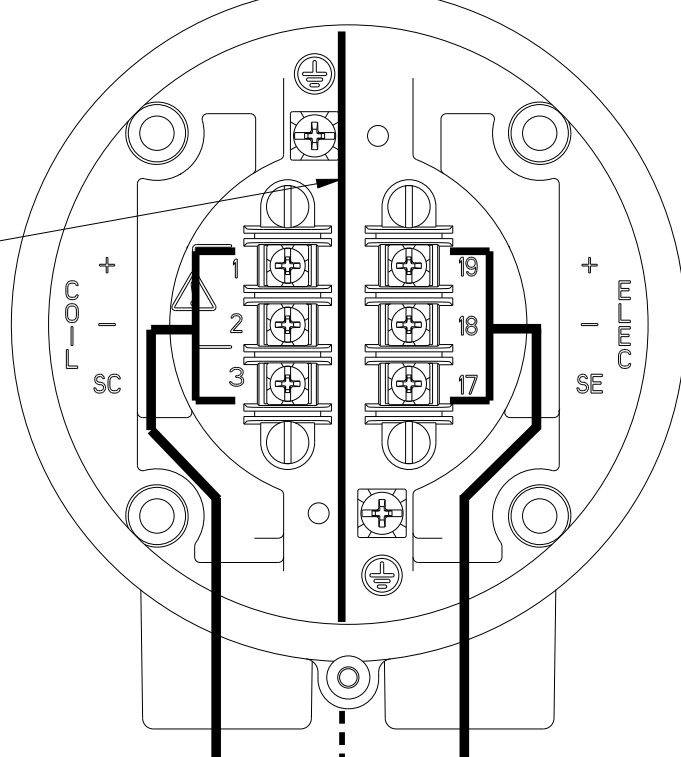

8750WDMR TRANSMITTER
 REMOTE JUNCTION BOX

MODEL 8750WD WITH NON-INTRINSICALLY SAFE ELECTRODE CIRCUIT
 FOR USE WITH SAFETY APPROVAL OPTION ZC
 COMPONENT OR COMBINATION COIL/ELECTRODE CABLE ALLOWED.
 SEE INSTALLATION WIRING DRAWING 08712-1504 FOR NON-INTRINSICALLY SAFE CABLING
 (FOR PROCESS TEMPERATURE LIMITS SEE TABLE 2)

OPTIONAL DIVIDER SHOWN

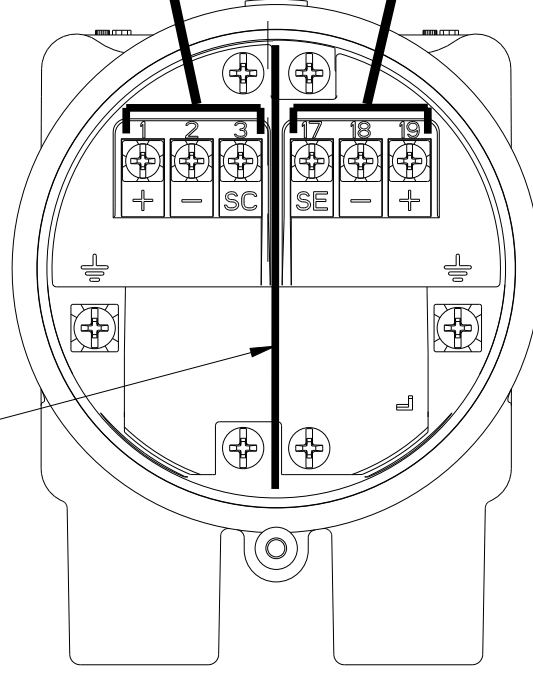

NON-INTRINSICALLY SAFE COIL CIRCUIT
 INSTALL USING EPL Dc WIRING
 METHODS APPROPRIATE TO THE AREA
 DEVICE IS INSTALLED IN

FOR USE WITH NON-FLAMMABLE PROCESS ONLY.
 INSTALL ELECTRODE CIRCUIT AS NON-INTRINSICALLY SAFE
 USING EPL Dc WIRING METHODS APPROPRIATE
 TO THE AREA DEVICE IS INSTALLED IN.

8750WDMR/W FLOWTUBE
 REMOTE JUNCTION BOX

TERMINAL	LABEL
NON-INTRINSICALLY SAFE ELECTRODE CIRCUIT	
19	ELECTRODE +
18	ELECTRODE -
17	ELECTRODE REFERENCE (SE)
NON-INTRINSICALLY SAFE COIL CIRCUIT	
1	COIL +
2	COIL -
3	COIL SHIELD (SC)

OPTIONAL
 DIVIDERS
 SHOWN

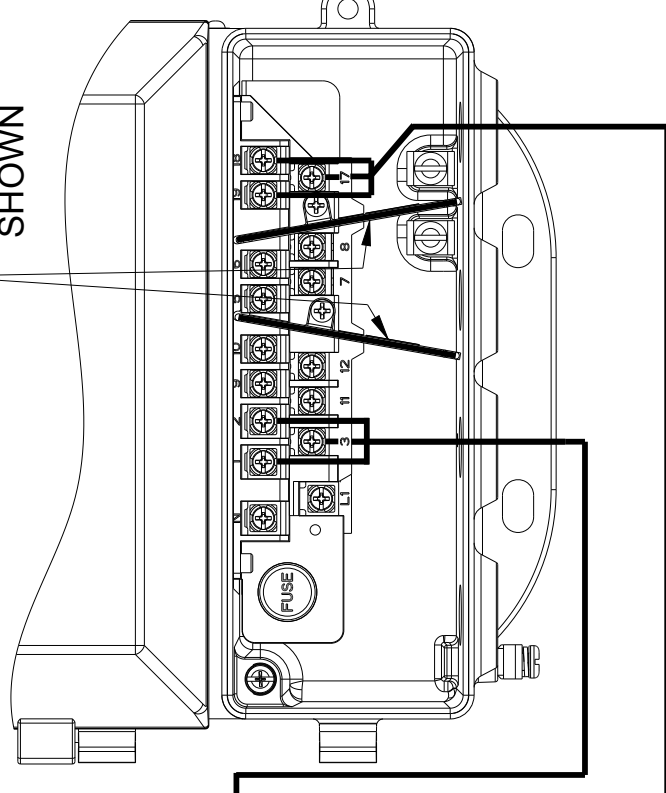

8750WDMW TRANSMITTER
 (LOWER COVER AND SAFETY COVER ARE NOT SHOWN)

8750W-2051
 DRAWING NO.

CONFIDENTIAL AND PROPRIETARY INFORMATION IS CONTAINED HEREIN AND MUST BE HANDLED ACCORDINGLY.	SURFACE FINISH UNLESS OTHERWISE SPECIFIED	125°	3RD ANGLE	SIZE	C	SCALE	-	REV	AC
	UNLESS OTHERWISE SPECIFIED DIMENSIONS IN INCHES (mm). REMOVE ALL BURRS AND SHARP EDGES.								
-DEC TOLERANCES- X ± .1 (2.5) .XX ± .02 (0.5) .XXX ± .010 (0.25) FRACTIONS ± 1/32 ANGLES ± 2°									
EMERSON		ROSEMOUNT			TITLE				
					INSTALLATION DRAWING 8750W, CSA CANADIAN AND USA ZONE				
DR.		J. LAGE	9/16/15	DRAWING NO.		8750W-2051			
APPD.		M. MAYER	9/16/15	PRODUCT CODE		DO NOT SCALE PRINT CAD MAINTAINED. (PROE)			
		DOC TYPE			SHEET8		OF 11		

GAS AND DUST ENVIRONMENT - OUTPUT WIRING

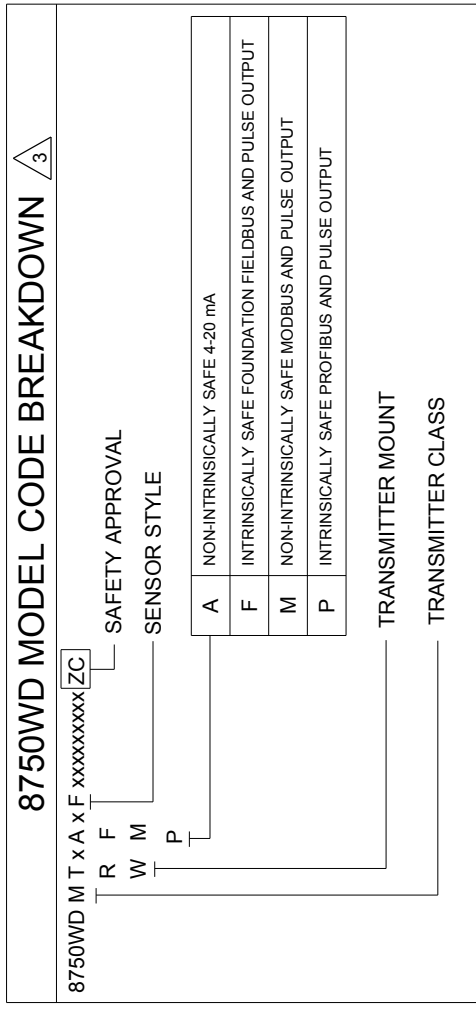
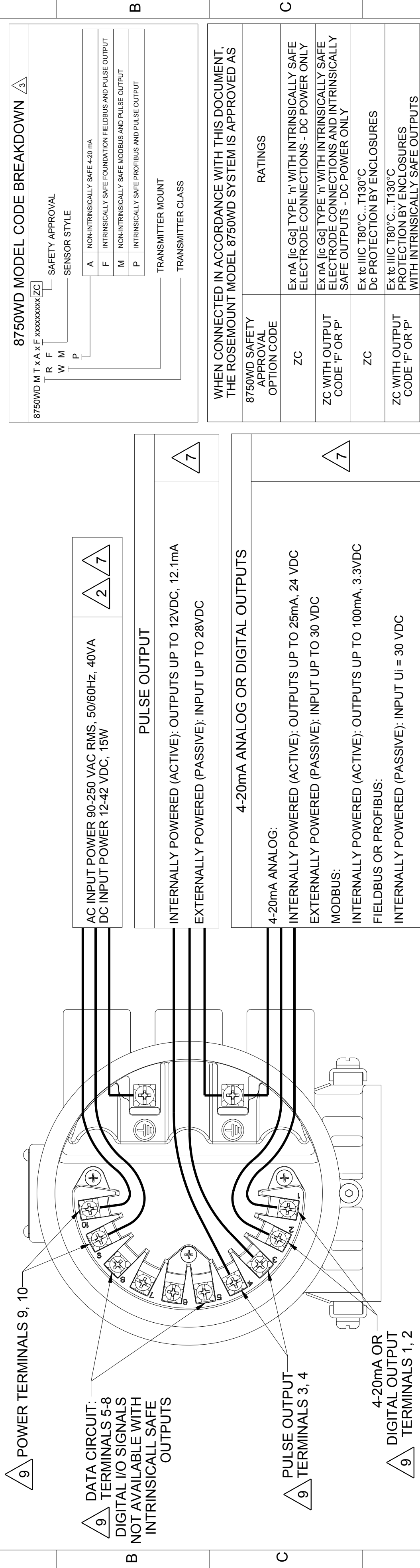

WHEN CONNECTED IN ACCORDANCE WITH THIS DOCUMENT, THE ROSEMOUNT MODEL 8750WD SYSTEM IS APPROVED AS

8750WD SAFETY APPROVAL OPTION CODE	RATINGS
ZC	Ex nA [ic Gc] TYPE 'n' WITH INTRINSICALLY SAFE ELECTRODE CONNECTIONS - DC POWER ONLY
ZC WITH OUTPUT CODE 'F' OR 'P'	Ex nA [ic Gc] TYPE 'n' WITH INTRINSICALLY SAFE ELECTRODE CONNECTIONS AND INTRINSICALLY SAFE OUTPUTS - DC POWER ONLY
ZC	Ex tc IIIC T80°C...T130°C Dc PROTECTION BY ENCLOSURES
ZC WITH OUTPUT CODE 'F' OR 'P'	Ex tc IIIC T80°C...T130°C PROTECTION BY ENCLOSURES WITH INTRINSICALLY SAFE OUTPUTS

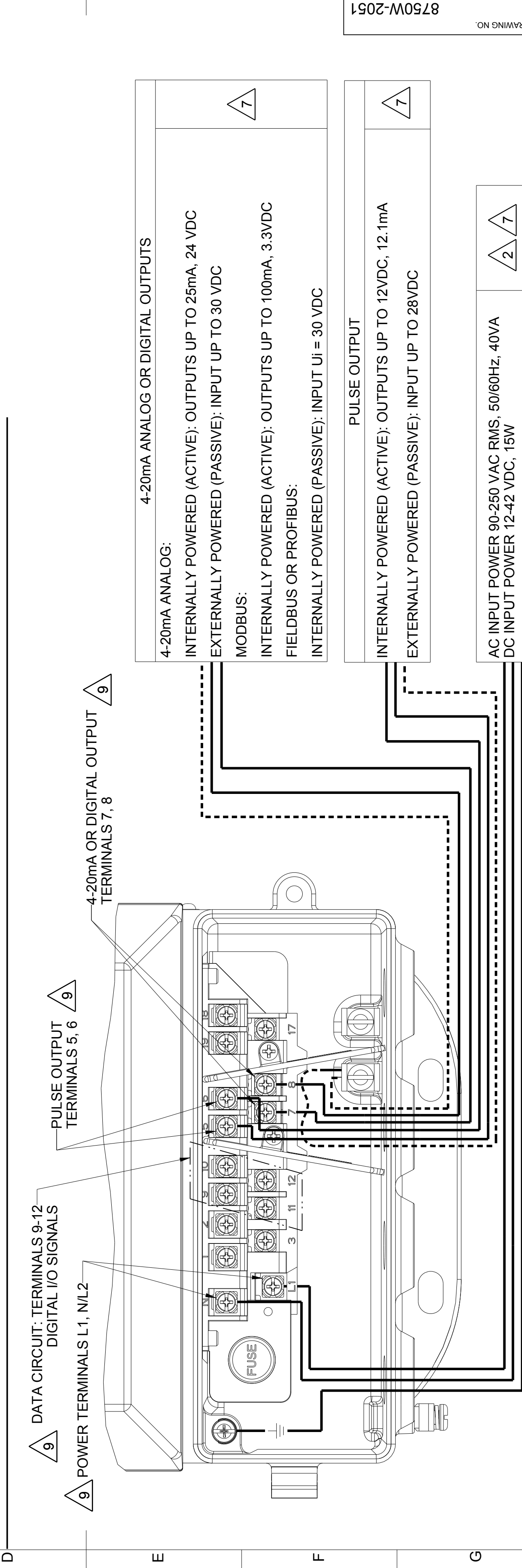

CONFIDENTIAL AND PROPRIETARY INFORMATION IS CONTAINED HEREIN AND MUST BE HANDLED ACCORDINGLY.	SURFACE FINISH UNLESS OTHERWISE SPECIFIED	125	3RD ANGLE	SIZE	C	SCALE	1:1	REV	AC										
UNLESS OTHERWISE SPECIFIED DIMENSIONS IN INCHES (mm). REMOVE ALL BURRS AND SHARP EDGES.	<table border="1"> <tr> <td>-DEC TOLERANCES-</td> <td></td> </tr> <tr> <td>X ± .1</td> <td>[2.5]</td> </tr> <tr> <td>.XX ± .02</td> <td>[0.5]</td> </tr> <tr> <td>.XXX ± .010</td> <td>[0.25]</td> </tr> <tr> <td>FRACTIONS ± 1/32</td> <td>ANGLES ± 2°</td> </tr> </table>									-DEC TOLERANCES-		X ± .1	[2.5]	.XX ± .02	[0.5]	.XXX ± .010	[0.25]	FRACTIONS ± 1/32	ANGLES ± 2°
-DEC TOLERANCES-																			
X ± .1	[2.5]																		
.XX ± .02	[0.5]																		
.XXX ± .010	[0.25]																		
FRACTIONS ± 1/32	ANGLES ± 2°																		
EMERSON																			
ROSEMOUNT																			
TITLE INSTALLATION DRAWING 8750W, CSA CANADIAN AND USA ZONE																			
DR.	J. LAGE	9/16/15	DRAWING NO.	8750W-2051															
APPD.	M. MAYER	9/16/15	DOC TYPE	SHEET9 OF 11															

1 2 3 4 5 6 7 8 9 10 11 12

A B C D E F G H

GAS ENVIRONMENT - INTRINSICALLY SAFE ENTITY CONCEPTS

8750WDMT/R ENTITY CONCEPT FOR INTRINSICALLY SAFE OUTPUTS

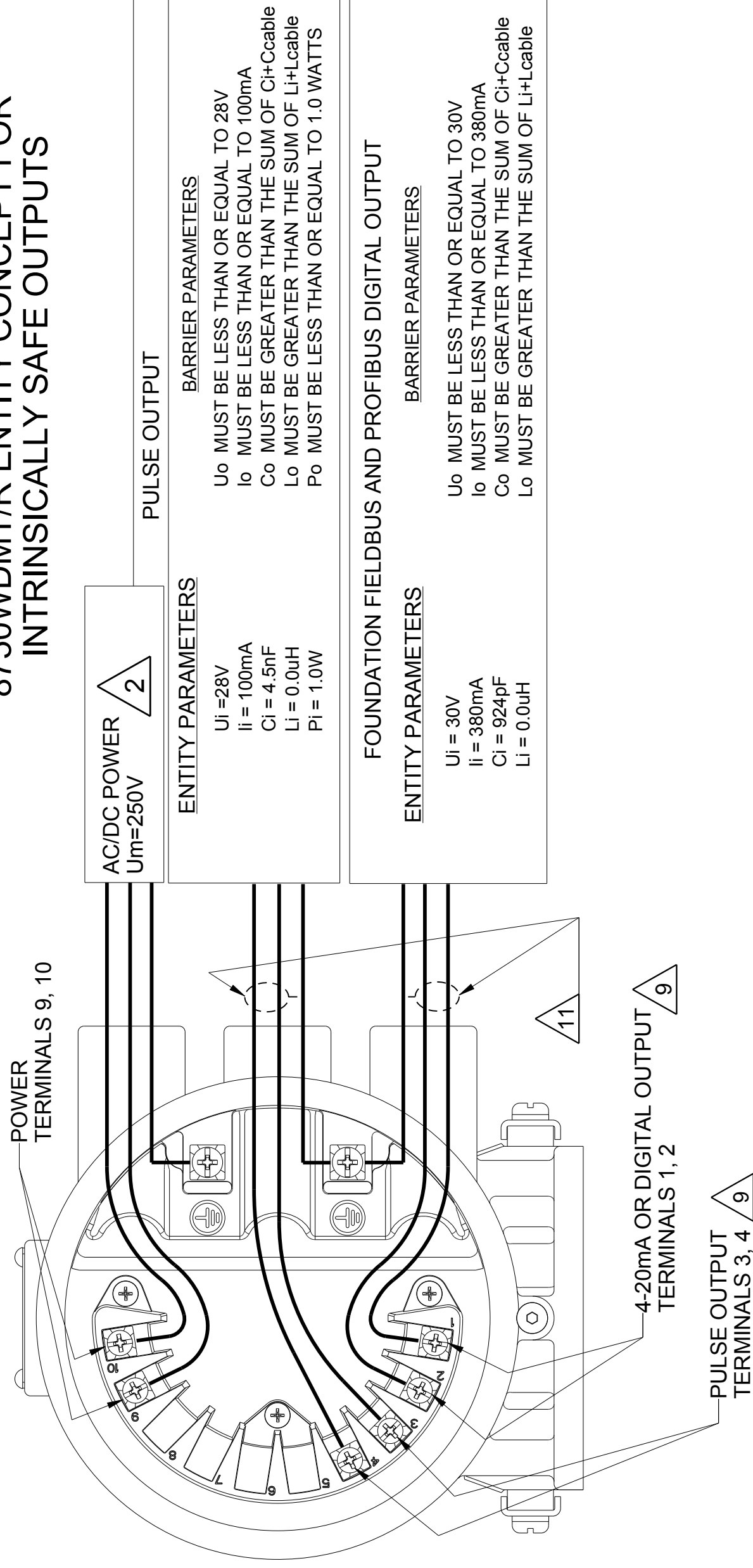

DEFINITIONS:

- U_i = MAXIMUM INPUT VOLTAGE
- I_i = MAXIMUM INPUT CURRENT
- C_i = MAXIMUM INTERNAL CAPACITANCE
- L_i = MAXIMUM INTERNAL INDUCTANCE
- P_i = MAXIMUM INPUT POWER
- U_o = OPEN CIRCUIT VOLTAGE OF THE BARRIER
- I_o = SHORT CIRCUIT CURRENT OF THE BARRIER
- C_o = MAXIMUM ALLOWED CAPACITANCE
- L_o = MAXIMUM ALLOWED INDUCTANCE
- P_o = MAXIMUM OUTPUT POWER

THE ENTITY CONCEPT ALLOWS INTERCONNECTION OF ASSOCIATED APPARATUS AND INTRINSICALLY SAFE APPARATUS WHEN THE FOLLOWING IS TRUE:
 $U_o \leq U_i$, $I_o \leq I_i$, $P_o \leq P_i$, $C_o \geq C_i + C_{cable}$, $L_o \geq L_i + L_{cable}$

ASSOCIATED APPARATUS MUST BE CSA APPROVED, AND FOLLOW MANUFACTURER'S INSTALLATION DRAWINGS. TO MAINTAIN THE INTRINSICALLY SAFE OUTPUT THE MODEL 8732EM MUST BE CONNECTED TO AN CSA APPROVED BARRIER THAT SATISFIES THE FOLLOWING CONDITIONS.

APPROVED WITH INTRINSICALLY SAFE CONNECTIONS FOR CLASS I, DIVISION 1, GROUPS ABCD; CLASS II AND III, DIVISION 1, GROUPS EFG.

8750WDMW ENTITY CONCEPT FOR INTRINSICALLY SAFE OUTPUTS

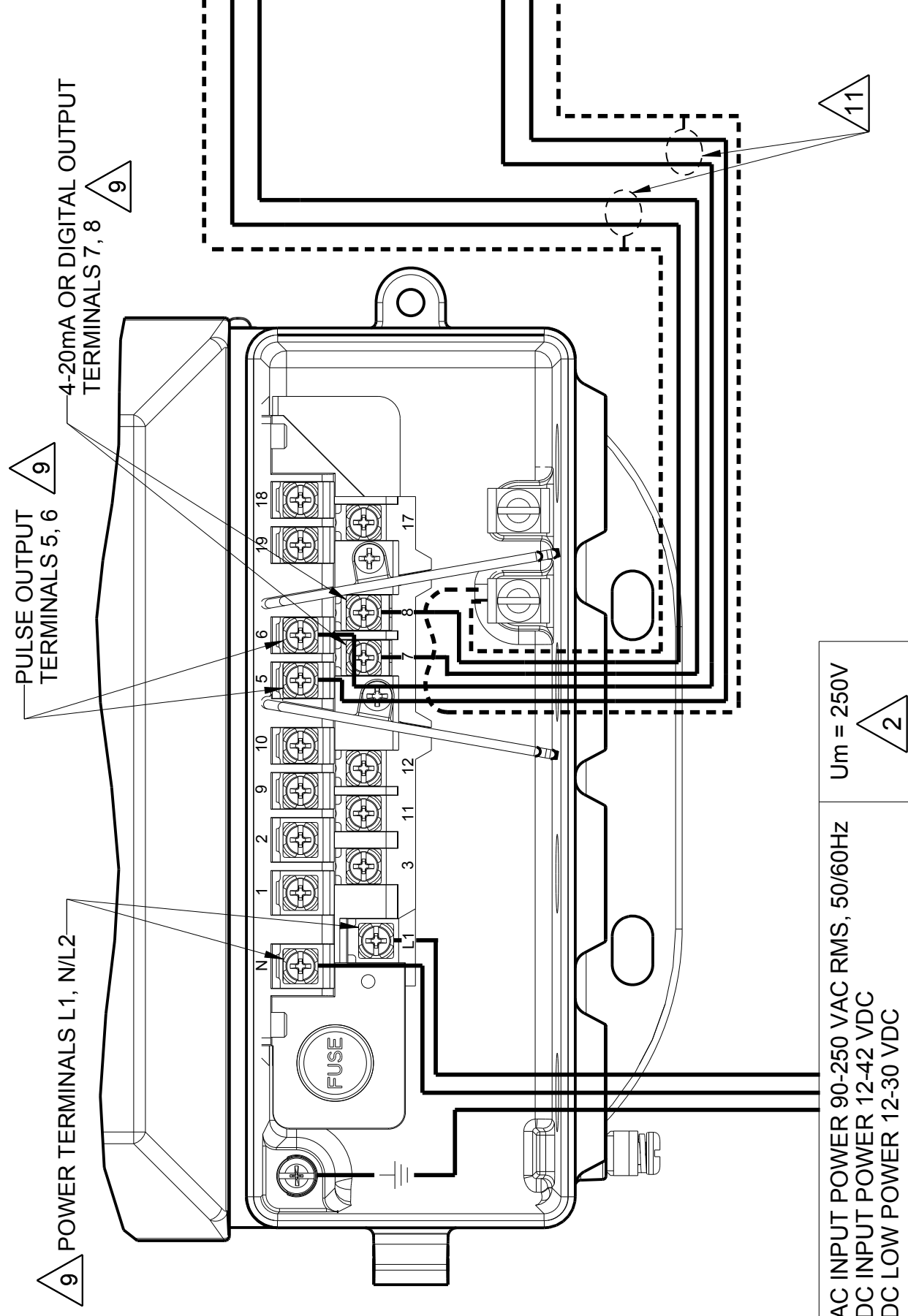

FOUNDATION FIELDBUS AND PROFIBUS DIGITAL OUTPUT

ENTITY PARAMETERS

- U_i = 30V
- I_i = 380mA
- C_i = 924pF
- L_i = 0.0uH

BARRIER PARAMETERS

- U_o MUST BE LESS THAN OR EQUAL TO 30V
- I_o MUST BE LESS THAN OR EQUAL TO 380mA
- C_o MUST BE GREATER THAN THE SUM OF C_i+C_{cable}
- L_o MUST BE GREATER THAN THE SUM OF L_i+L_{cable}

PULSE OUTPUT

ENTITY PARAMETERS

- U_i = 28V
- I_i = 100mA
- C_i = 4.5nF
- L_i = 0.0uH
- P_i = 1.0W

BARRIER PARAMETERS

- U_o MUST BE LESS THAN OR EQUAL TO 28V
- I_o MUST BE LESS THAN OR EQUAL TO 100mA
- C_o MUST BE GREATER THAN THE SUM OF C_i+C_{cable}
- L_o MUST BE GREATER THAN THE SUM OF L_i+L_{cable}
- P_o MUST BE LESS THAN OR EQUAL TO 1.0 WATTS

CONFIDENTIAL AND PROPRIETARY INFORMATION IS CONTAINED HEREIN AND MUST BE HANDLED ACCORDINGLY.	SURFACE FINISH UNLESS OTHERWISE SPECIFIED	12/5	3RD ANGLE	SIZE	SCALE	REV
				C		AC
ROSEMOUNT						
TITLE INSTALLATION DRAWING 8750W, CSA CANADIAN AND USA ZONE						
UNLESS OTHERWISE SPECIFIED DIMENSIONS IN INCHES (mm). REMOVE ALL BURRS AND SHARP EDGES.						
-DEC TOLERANCES- X ± .1 [2.5] .XX ± .02 [0.5] .XXX ± .010 [0.25]						
FRACTIONS ± 1/32 ANGLES ± 2°						
DO NOT SCALE PRINT CAD MAINTAINED: (PROE) PRODUCT CODE						
DR. J. LAGE 9/16/15 DRAWING NO. 8750W-2051 APPD. M. MAYER 9/16/15						
FORM REV A0 SHEET 10 OF 11						

AC INPUT POWER 90-250 VAC RMS, 50/60Hz
 DC INPUT POWER 12-42 VDC
 DC LOW POWER 12-30 VDC

DRAWING NO. 8750W-2051

GAS ENVIRONMENT - FISCO CONCEPT

FISCO CONCEPT

THE FISCO CONCEPT ALLOWS INTERCONNECTION OF INTRINSICALLY SAFE APPARATUS TO ASSOCIATED APPARATUS NOT SPECIALLY EXAMINED IN SUCH COMBINATION. THE CRITERIA FOR INTERCONNECTION IS THAT THE VOLTAGE (V_{max}), THE CURRENT (I_{max}), AND THE POWER (P_{max}) WHICH AN INTRINSICALLY SAFE APPARATUS CAN RECEIVE AND REMAIN INTRINSICALLY SAFE CONSIDERING FAULTS, MUST BE EQUAL OR GREATER THAN VOLTAGE (V_{oc}), AND CURRENT (I_{sc}) WHICH CAN BE DELIVERED BY THE ASSOCIATED APPARATUS, CONSIDERING FAULTS AND APPLICABLE FACTORS. IN ADDITION, THE MAXIMUM UNPROTECTED CAPACITANCE (C_i) AND THE INDUCTANCE (L_i) OF EACH APPARATUS (OTHER THAN THE TERMINATION) CONNECTED TO THE FIELD BUS MUST BE LESS THAN OR EQUAL TO 5 nF AND 10 μ H RESPECTIVELY.

IN EACH SEGMENT ONLY ONE ACTIVE DEVICE, NORMALLY THE ASSOCIATED APPARATUS, IS ALLOWED TO PROVIDE THE NECESSARY ENERGY FOR THE FIELD BUS SYSTEM. THE VOLTAGE (V_{oc}) OF THE ASSOCIATED APPARATUS IS LIMITED TO A RANGE OF 14 TO 17.5 VDC. ALL OTHER EQUIPMENT CONNECTED TO THE BUS CABLE HAS TO BE PASSIVE, MEANING THAT THEY ARE NOT ALLOWED TO PROVIDE ENERGY TO THE SYSTEM, EXCEPT A LEAKAGE CURRENT OF 50 μ A FOR EACH CONNECTED DEVICE. SEPARATELY POWERED EQUIPMENT NEEDS GALVANIC ISOLATION TO ASSURE THAT THE INTRINSICALLY SAFE FIELD BUS CIRCUIT REMAINS PASSIVE.

THE CABLE USED TO INTERCONNECT DEVICES NEEDS TO HAVE THE PARAMETERS IN THE FOLLOWING RANGE:

- Loop Resistance R_c : 15.....150 Ohm/km
- Inductance per unit length L_c : 0.4.....1 mH/km
- Capacitance per unit length C_c : 45.....200 nF
- Length of trunk cable: less than or equal to 1000m
- Length of spur cable: less than or equal to 60m

AT EACH END OF THE TRUNK CABLE AN APPROVED INFALLIBLE LINE TERMINATION WITH THE FOLLOWING PARAMETERS IS SUITABLE:

$$R = 90.....102 \text{ Ohm} \quad C = 0.....2.2 \mu\text{f}$$

ONE OF THE ALLOWED TERMINATIONS MIGHT ALREADY BE INTEGRATED IN THE ASSOCIATED APPARATUS. THE NUMBER OF PASSIVE APPARATUS CONNECTED TO THE BUS SEGMENT IS NOT LIMITED TO I.S. REASONS. IF THE ABOVE RULES ARE RESPECTED, UP TO A TOTAL LENGTH OF 1000 m (SUM OF TRUNK AND ALL SPUR CABLES) OF CABLE IS PERMITTED. THE INDUCTANCE AND THE CAPACITANCE OF THE CABLE WILL NOT IMPAIR THE INTRINSIC SAFETY OF THE INSTALLATION.

ENTITY PARAMETER

- $U_i = 30V$
- $I_i = 380 \text{ mA}$
- $C_i = 924 \text{ pF}$
- $L_i = 0.0 \mu\text{H}$
- $P_i = 5.32 \text{ W}$

BARRIER PARAMETERS

- U_o MUST BE LESS THAN OR EQUAL TO 30V
- I_o MUST BE LESS THAN OR EQUAL TO 380 mA
- C_o MUST BE GREATER THAN THE SUM OF $C_i + C_{cable}$
- L_o MUST BE GREATER THAN THE SUM OF $L_i + L_{cable}$

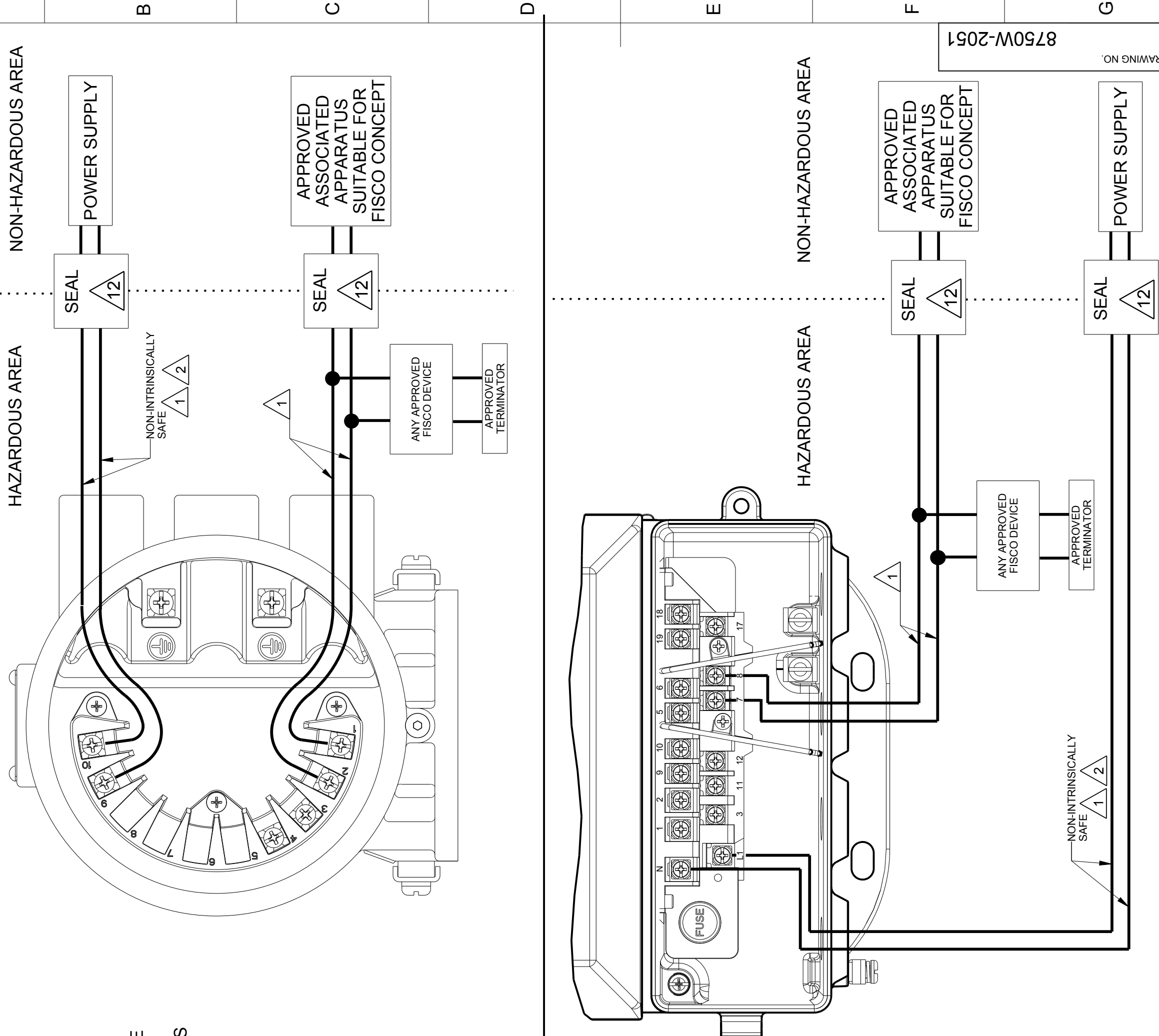

CONFIDENTIAL AND PROPRIETARY INFORMATION IS CONTAINED HEREIN AND MUST BE HANDLED ACCORDINGLY.	SURFACE FINISH UNLESS OTHERWISE SPECIFIED	125	3RD ANGLE	SIZE	C	SCALE	AC	REV	AC	
	<p style="text-align: center;">EMERSON</p> <p style="text-align: center;">ROSEMOUNT</p> <p style="text-align: center;">TITLE INSTALLATION DRAWING 8750W, CSA CANADIAN AND USA ZONE</p> <p style="text-align: center;">DRAWING NO. 8750W-2051</p> <p>DR. J. LAGE 9/16/15 APPD. M. MAYER 9/16/15</p>									
UNLESS OTHERWISE SPECIFIED DIMENSIONS IN INCHES (mm). REMOVE ALL BURRS AND SHARP EDGES.	<p>-DEC TOLERANCES-</p> <p>X ± .1 [2.5]</p> <p>.XX ± .02 [0.5]</p> <p>.XXX ± .010 [0.25]</p> <p>FRACTIONS ± 1/32 ANGLES ± 2'</p>									
DO NOT SCALE PRINT	CAD MAINTAINED. (PROE)	PRODUCT CODE	DOC TYPE	SHEET 11 OF 11						



00825-MA00-0006, Rev. AB
May 2019

Emerson Automation Solutions USA

7070 Winchester Circle
Boulder, Colorado USA 80301
T +1 303-527-5200
T +1 800-522-6277
F +1 303-530-8459
www.emerson.com

Emerson Automation Solutions Asia

1 Pandan Crescent
Singapore 128461
Republic of Singapore
T +65 6363-7766
F +65 6770-8003

Emerson Automation Solutions Europe

Neonstraat 1
6718 WX Ede
The Netherlands
T +31 (0) 70 413 6666
F +31 (0) 318 495 556
www.micromotion.nl

Emerson Automation Solutions United Kingdom

Emerson Process Management Limited
Horsfield Way
Bredbury Industrial Estate
Stockport SK6 2SU U.K.
T +44 0870 240 1978
F +44 0800 966 181

©2019 Rosemount, Inc. All rights reserved.

The Emerson logo is a trademark and service mark of Emerson Electric Co. Rosemount, 8600, 8700, 8800 marks are marks of one of the Emerson Automation Solutions family of companies. All other marks are property of their respective owners.

ROSEMOUNT™

EMERSON®