

Rosemount™ 248 Temperature Transmitter

Reference Manual



NOTICE

Read this manual before working with the product. For personal and system safety, and for optimum product performance, make sure to thoroughly understand the contents before installing, using, or maintaining this product.

The United States has two toll-free assistance numbers and one international number.

Customer Central	1 800 999 9307 (7:00 am to 7:00 pm CST)
National Response Center	1 800 654 7768 (24 hours a day) Equipment service needs
International	1 952 906 8888

⚠ CAUTION

The products described in this document are NOT designed for nuclear-qualified applications.

Using non-nuclear qualified products in applications that require nuclear-qualified hardware or products may cause inaccurate readings.

For information on Rosemount nuclear-qualified products, contact an Emerson Sales Representative.

⚠ WARNING

Failure to follow these installation guidelines could result in death or serious injury.

Ensure only qualified personnel perform the installation.

Explosions could result in death or serious injury.

Do not remove the housing covers in explosive atmospheres when the circuit is live.

Before connecting a handheld communicator in an explosive atmosphere, ensure the instruments are installed in accordance with intrinsically safe or non-incendive field wiring practices.

Verify that the operating atmosphere of the transmitter is consistent with the appropriate hazardous locations certifications.

All connection head covers must be fully engaged to meet explosion-proof requirements.

Process leaks could result in death or serious injury.

Do not remove the thermowell while in operation.

Install and tighten thermowells and sensors before applying pressure.

Electrical shock could cause death or serious injury.

Use extreme caution when making contact with the leads and terminals.

Physical access

Unauthorized personnel may potentially cause significant damage to and/or misconfiguration of end users' equipment. This could be intentional or unintentional and needs to be protected against.

Physical security is an important part of any security program and fundamental to protecting your system. Restrict physical access by unauthorized personnel to protect end users' assets. This is true for all systems used within the facility.

Contents

Chapter 1	Introduction.....	5
	1.1 Using this Manual.....	5
	1.2 Transmitter overview.....	5
	1.3 Product recycling/disposal.....	7
Chapter 2	Installation.....	9
	2.1 Safety messages.....	9
	2.2 Confirm HART revision capability.....	9
	2.3 Switch HART revision mode.....	10
	2.4 Considerations.....	10
	2.5 Mounting.....	12
	2.6 Installing the transmitter.....	13
	2.7 Multichannel installations.....	17
	2.8 Set the switches.....	18
	2.9 Wiring.....	19
	2.10 Power supply.....	23
Chapter 3	Configuration.....	27
	3.1 Safety messages.....	27
	3.2 Commissioning.....	27
	3.3 AMS Device Manager.....	28
	3.4 Field Communicator.....	29
	3.5 Multidrop communication.....	40
	3.6 Rosemount 248 Configuration Interface specifications.....	41
Chapter 4	Operation and maintenance.....	43
	4.1 Safety messages.....	43
	4.2 Calibration.....	43
	4.3 Transmitter-Sensor Natching.....	45
	4.4 Switching HART Revision.....	47
	4.5 Hardware Maintenance.....	48
	4.6 Diagnostic messages.....	48
Chapter 5	Safety Instrumented Systems (SIS) requirements.....	53
	5.1 SIS certification.....	53
	5.2 Identify safety certification.....	53
	5.3 Installation.....	53
	5.4 Configuration.....	54
	5.5 Operation and maintenance.....	54
	5.6 Specifications.....	56

Appendix A	Reference data.....	57
	A.1 Product certifications.....	57
	A.2 Ordering Information, Specifications, and Drawings.....	57

1 Introduction

1.1 Using this Manual

This manual is designed to assist in the installation, operation, and maintenance of the Rosemount™ 248 Temperature Transmitter.

Introduction

- Manual overview
- Transmitter overview

Installation

- Things to consider
- How to mount the transmitter
- How to install the transmitter
- How to set the switches to ensure proper use
- How to wire and power up the transmitter

Configuration

- Commissioning to transmitter
- How to use the Field Communicator to configure the transmitter

Operation and maintenance

- Calibrate the transmitter
- Explanation of hardware maintenance and diagnostic messages
- How to return the transmitter

Reference data

- Product certifications/Hazardous locations certifications
- Specifications
- Dimensional drawings
- Ordering information

1.2 Transmitter overview

Features of the Rosemount 248 include:

- Acceptance of inputs from a wide variety of RTD and thermocouple sensors
- Configuration using HART® protocol
- Electronics encapsulated in epoxy and enclosed in a plastic housing, making the transmitter extremely durable and ensuring long-term reliability

- IEC 61508:2010 safety certification
- A compact size and multiple housing options that allow mounting flexibility in the field
- Improve measurement accuracy with Transmitter-Sensor matching.

Refer to the following literature for a full range of compatible connection heads, sensors, and thermowells provided by Emerson:

- Rosemount 214C Temperature Sensors [Product Data Sheet](#)
- Rosemount Volume 1 Temperature Sensors and Accessories (English) [Product Data Sheet](#)
- Rosemount DIN-Style Temperature Sensors and Thermowells (Metric) [Product Data Sheet](#)

Table 1-1 and Table 1-2 summarize changes in the Rosemount 248 Head Mount and Rail Mount HART device revisions, respectively.

Table 1-1: Head Mount HART Revisions

Software release date	Identify device		Field device driver		Review instructions
	NAMUR software revision	NAMUR hardware revision ⁽¹⁾	HART universal revision ⁽²⁾	Device revision	Manual document number
Jun 2019	1.0.1.	1.0.2	7	7.4.11 ⁽³⁾	00809-0100-4825
			5	5.2.11 ⁽³⁾	
Dec 2005	N/A	N/A	5	5.2.2.	

- (1) NAMUR Software Revision is located in the hardware tag of the device. HART Software Revision can be read using a HART capable configuration tool.
- (2) Device Driver file names use Device and DD Revision, (e.g., 10_07. HART Protocol) is designed to enable legacy driver revisions to continue to communicate with new HART devices. To access this functionality, the new device driver must be downloaded. It is recommended to download the new device driver to ensure new functionality.
- (3) HART 5 and 7 Selectable, CVD sensor matching.

Table 1-2: Rail Mount HART Revisions

Software release date	Identify device		Field device driver		Review instructions
	NAMUR software revision	NAMUR hardware revision ⁽¹⁾	HART universal revision ⁽²⁾	Device revision	Manual document number
Mar 2005	N/A	N/A	5	5.2.1.	00809-0100-4825

- (1) NAMUR Software Revision is located in the hardware tag of the device. HART Software Revision can be read using a HART capable configuration tool.
- (2) Device Driver file names use Device and DD Revision, (e.g., 10_07. HART Protocol) is designed to enable legacy driver revisions to continue to communicate with new HART devices. To access this functionality, the new device driver must be downloaded. It is recommended to download the new device driver to ensure new functionality.

1.3 Product recycling/disposal

Recycling of equipment and packaging should be taken into consideration and disposed of in accordance with local and national legislation/regulations.

2 Installation

2.1 Safety messages

Instructions and procedures in this section may require special precautions to ensure the safety of the personnel performing the operations. Information that potentially raises safety issues is indicated by a warning symbol (⚠). Please refer to the following safety messages before performing an operation preceded by this symbol.

⚠ WARNING

Failure to follow these installation guidelines could result in death or serious injury.

Ensure only qualified personnel perform the installation.

Explosions could result in death or serious injury.

Do not remove the housing covers in explosive atmospheres when the circuit is live. Before connecting a handheld communicator in an explosive atmosphere, ensure the instruments are installed in accordance with intrinsically safe or non-incendive field wiring practices.

Verify that the operating atmosphere of the transmitter is consistent with the appropriate hazardous locations certifications.

All connection head covers must be fully engaged to meet explosion-proof requirements.

Process leaks could result in death or serious injury.

Do not remove the thermowell while in operation.

Install and tighten thermowells and sensors before applying pressure.

Electrical shock could cause death or serious injury.

Use extreme caution when making contact with the leads and terminals.

2.2 Confirm HART revision capability

If using HART® based control or asset management systems, confirm the HART Protocol capability of those systems prior to transmitter installation. Not all systems are capable of

communicating with HART Revision 7. This transmitter can be configured for either HART Revision 5 or Revision 7.

2.3 Switch HART revision mode

If the HART Protocol configuration tool is not capable of communicating with HART Revision 7, the transmitter will load a generic menu with limited capability. The following procedures will switch the HART Revision mode from the generic menu:

Procedure

Select **Manual Setup** → **Device Information** → **Identification** → **Message**.

- a) To change to HART Revision 5, enter `HART5` in the *Message* field.
- b) To change to HART Revision 7, enter `HART7` in the *Message* field.

2.4 Considerations

2.4.1 General

Electrical temperature sensors, such as RTDs and thermocouples, produce low-level signals proportional to the sensed temperature. The Rosemount™ 248 Temperature Transmitter converts the low-level sensor signal to a HART 4–20 mA dc signal that is relatively insensitive to lead length and electrical noise. This current signal is transmitted to the control room through two wires.

2.4.2 Commissioning

The transmitter may be commissioned before or after installation. It can be useful to commission it on the bench, before installation, to ensure proper operation and to become familiar with its functionality. The instruments in the loop should be installed according to the intrinsically safe or non-incendive field wiring practices before connecting a Field Communicator in an explosive atmosphere. For more information, see [Commissioning](#).

2.4.3 Mechanical

Location

When choosing an installation location, take into account access to the transmitter.

Special mounting

Special hardware is available for mounting the transmitter to a DIN rail.

2.4.4 Electrical

Proper electrical installation is necessary to prevent errors from sensor lead resistance and electrical noise. For best results, shielded cable should be used in electrically noisy

environments. A resistance between 250 and 1100 ohms must be present in the loop for communication with a Field Communicator.

Make wiring connections through the cable entry in the side of the connection head being sure to provide adequate clearance for cover removal.

2.4.5 Environmental

The transmitter electronics module is permanently sealed within the housing, to resist moisture and corrosive damage. Verify that the operating atmosphere of the transmitter is consistent with the appropriate hazardous locations certifications.

Temperature effects

The transmitter operates within specifications for ambient temperatures between -40 and 185 °F (-40 and 85 °C)⁽¹⁾. Process heat from the process is transferred from the thermowell to the transmitter housing so if the expected process temperature is near or above specification limits, consider using an additional thermowell lagging, and extension nipple, or a remote mounting configuration to isolate the transmitter from the process.

Note

Extended ranges available with BR5 and BR6 option codes for extending the lower ambient temperature limit to -58 and -76 °F (-50 and -60 °C), respectively.

Figure 2-1 provides an example of the relationship between transmitter housing temperature rise and extension length.

Figure 2-1: Connection Head Temperature Rise vs. Extension Length

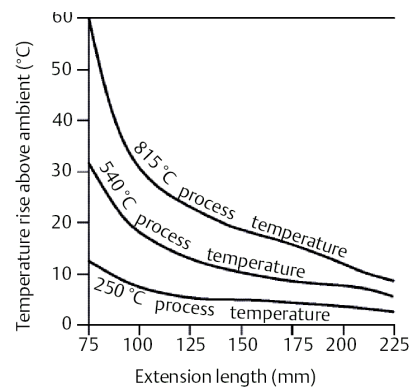

Example

The transmitter specification limit is 185 °F (85 °C). If the ambient temperature is 131 °F (55 °C) and the process temperature to be measured is 1472 °F (800 °C), the maximum permissible connection head temperature rise is the transmitter specification limit minus the ambient temperature (moves 185 to 131 °F [85 to 55 °C]), or 86 °F (30 °C). In this case, an extension of 3.93 -in. (100 mm) meets this requirement, but 4.92 -in. (125 mm) provides a margin of 46.4 °F (8 °C), reducing any temperature effects in the transmitter.

(1) Extended ranges available with BR5 and BR6 option codes.

2.4.6 Installation Flowchart

Figure 2-2: Installation Flowchart

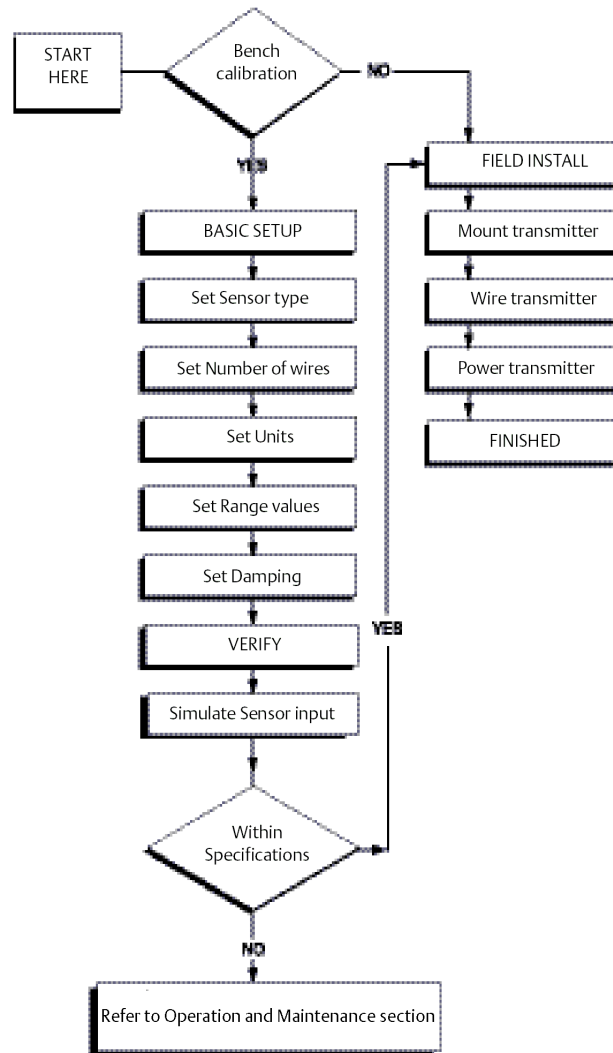

2.5 Mounting

Mount the transmitter at a high point in the conduit run to prevent moisture from draining into the transmitter housing.

The Rosemount 248R installs directly to a wall or to a DIN rail.

The Rosemount 248H installs:

- In a connection head or universal head mounted directly on a sensor assembly
- Apart from a sensor assembly using a universal head
- To a DIN rail using an optional mounting clip

2.5.1 Mounting a Rosemount 248H to a DIN rail

Procedure

- To attach a head mount transmitter to a DIN rail, assemble the appropriate rail mounting kit (part number 00248-1601-0001).

Figure 2-3: Assembling Rail Clip Hardware to a Rosemount 248

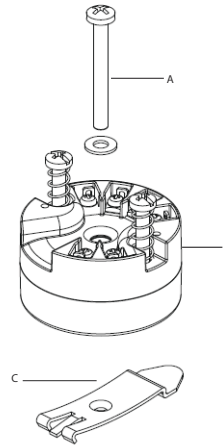

- A. Mounting hardware
- B. Transmitter
- C. Rail clip

2.6 Installing the transmitter

The Rosemount 248 can be ordered assembled to a sensor and thermowell or as a stand-alone unit. If ordered without the sensor assembly, use the following guidelines when installing the transmitter with an integral sensor assembly.

2.6.1 Typical European and Asia Pacific installation

Head mount transmitter with DIN plate style sensor

Procedure

- Attach the thermowell to the pipe or process container wall then install and tighten the thermowell before applying process pressure.
- Assemble the transmitter to the sensor. Push the transmitter mounting screws through the sensor mounting plate and insert the snap rings (optional) into the transmitter mounting screw groove.
- Wire the sensor to the transmitter (see [Sensor connections](#)).
- Insert the transmitter-sensor assembly into the connection head. Thread the transmitter mounting screw into the connection head mounting holes and

assemble the extension to the connection head then insert the assembly into the thermowell.

5. Slip the shielded cable through the cable gland.
6. Attach a cable gland into the shielded cable.
7. Insert the shielded cable leads into the connection head through the cable entry then connect and tighten the cable gland.
8. Connect the shielded power cable leads to the transmitter power terminals making sure to avoid contact with sensor leads and sensor connections.
9. Install and tighten the connection head cover making sure the enclosure covers are fully engaged to meet explosion-proof requirements.

Figure 2-4: European and Asia Pacific installation diagram

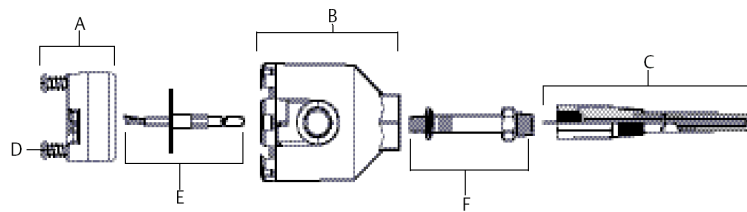

- A. Rosemount 248 transmitter
- B. Connection head
- C. Thermowell
- D. Transmitter mounting screws
- E. Integral mount sensor with flying leads
- F. Extension

2.6.2 Typical North and South American installation

Head mount transmitter with threaded sensor

Procedure

1. Attach the thermowell to the pipe or process container wall then install and tighten thermowells before applying process pressure.
2. Attach necessary extension nipples and adapters to the thermowell making sure to seal the nipple and adapter threads with silicone tape.
3. Twist the sensor into the thermowell and install drain seals, if required, for severe environments or to satisfy code requirements.
4. Pull the sensor wiring leads through the universal head and transmitter. Mount the transmitter in the universal head by threading the transmitter mounting screws into the universal head mounting holes.
5. Mount the transmitter-sensor assembly into the thermowell, sealing the adapter threads with silicone tape.
6. Install conduit for field wiring to the conduit entry of the universal head. Seal the conduit threads with silicone tape.

7. Pull the field wiring leads through the conduit into the universal head. Attach the sensor and power leads to the transmitter. Avoid contact with other terminals.
8. Install and tighten the universal head cover. Enclosure covers must be fully engaged to meet explosion-proof requirements.

Figure 2-5: North and South American Installation

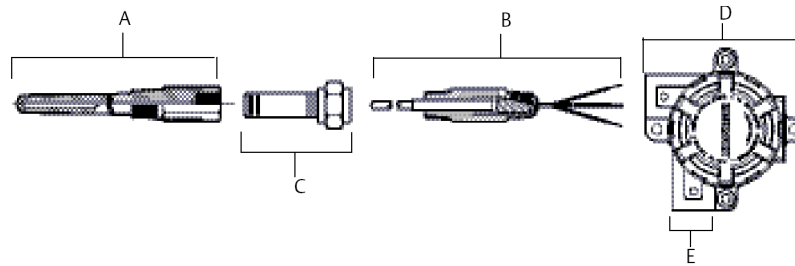

- A. Threaded thermowell
- B. Threaded style sensor
- C. Standard extension
- D. Universal head
- E. Conduit entry

Rail mount transmitter with integral mount sensor

The least complicated assembly uses:

- an integral mount sensor with terminal block
- an integral DIN style connection head
- a standard extension
- a threaded thermowell

Refer to the appropriate Product Data Sheet regarding Rosemount temperature elements for complete sensor and mounting accessory information.

To complete the assembly:

Procedure

1. Attach the transmitter to a suitable rail or panel.
2. Attach the thermowell to the pipe or process container wall. Install and tighten the thermowell before applying pressure.
3. Attach the sensor to the connection head and mount the entire assembly to the thermowell.
4. Attach sufficient lengths of sensor lead wire to the sensor terminal block.
5. Attach and tighten the connection head cover. Enclosure covers must be fully engaged to meet explosion-proof requirements.
6. Run sensor lead wires from the sensor assembly to the transmitter.
7. Attach the sensor and power leads to the transmitter. Avoid contact with leads and terminals.

Figure 2-6: Typical Rail Mount Transmitter Mounting Configuration Using Integral Mount Sensor and Assembly

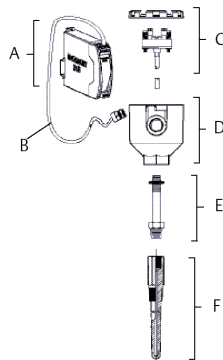

- A. Rail mount transmitter
- B. Sensor leads with cable gland
- C. Integral mount sensor with terminal block
- D. Connection head
- E. Standard extension
- F. Threaded thermowell

Rail mount transmitter with threaded sensor

The least complicated assembly uses:

- a threaded sensor with flying heads
- a threaded sensor connection head
- a union and nipple extension assembly
- a threaded thermowell

Refer to the appropriate Product Data Sheet regarding Rosemount temperature elements for complete sensor and mounting accessory information.

To complete the assembly:

Procedure

1. Attach the transmitter to a suitable rail or panel.
2. Attach the thermowell to the pipe or process container wall. Install and tighten the thermowell before applying pressure.
3. Attach necessary extension nipples and adapters. Seal the nipple and adapter threads with silicone tape.
4. Twist the sensor into the thermowell. Install drain seals if required for severe environments or to satisfy code requirements.
5. Screw the connection head to the sensor.
6. Attach the sensor lead wires to the connection head terminals.
7. Attach additional sensor lead wires from the connection head to the transmitter.

8. Attach and tighten the connection head cover. Enclosure covers must be fully engaged to meet explosion-proof requirements.
9. Attach the sensor and power leads to the transmitter. Avoid contact with leads and terminals.

Figure 2-7: Typical Rail Mount Transmitter Mounting Configuration Using Threaded Style Sensor and Assembly

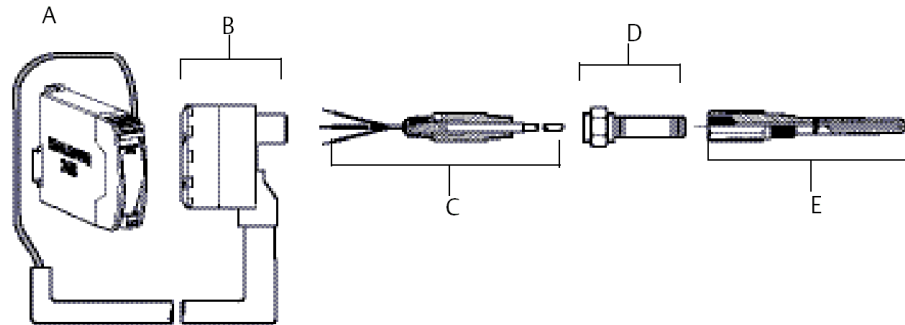

- A. Rail mount transmitter
- B. Threaded sensor connection head
- C. Threaded style sensor
- D. Standard extension
- E. Threaded thermowell

2.7 Multichannel installations

Several transmitters can be connected to a single master power supply, as shown in [Figure 2-8](#). In this case, the system may be grounded only at the negative power supply terminal. In multichannel installations, where several transmitters are dependent on one power supply and the loss of all transmitters would cause operational problems, consider an uninterrupted power supply or a back-up battery. The diodes shown in [Figure 2-8](#) prevent unwanted charging or discharging of the back-up battery.

Figure 2-8: Multichannel Installations

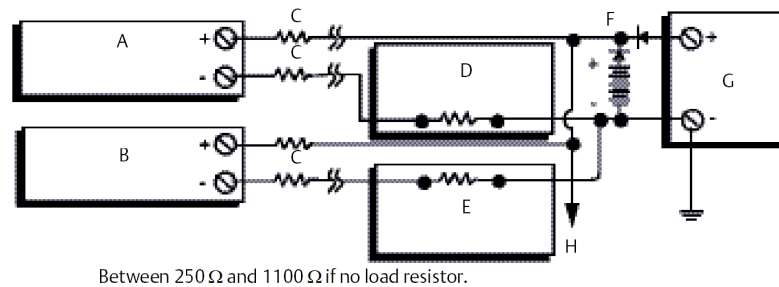

- A. Transmitter 1
- B. Transmitter 2
- C. R_{Lead}
- D. Readout or controller no. 1
- E. Readout or controller no. 2
- F. Backup battery
- G. Power supply (dc)
- H. To additional transmitters

2.8 Set the switches

2.8.1 Failure mode

Each transmitter continuously monitors its performance during normal operation with an automatic diagnostic routine of continuous timed series of checks. If an input sensor failure or a transmitter electronics failure is detected, the transmitter outputs the low or high alarm, depending on the failure mode configuration. For sensor temperature outside of range limits:

Standard saturation levels:

- 3.90 mA on the low end
- 20.5 mA on the high end

NAMUR compliant saturation levels:

- 3.80 mA on the low end
- 20.5 mA on the high end

These values are also custom configurable by the factory or using the Field Communicator or AMS Device Manager. See for instructions on how to change the alarm and saturation levels with the Field Communicator.

Note

Microprocessor failures cause high alarm regardless of alarm direction (high or low) choice.

The values the transmitter drives its output in failure mode depend on if it is configured to standard, NAMUR-compliant, or custom operation.

2.9 Wiring

All power to the transmitter is supplied over the signal wiring. Ordinary copper wire of sufficient size should be used to ensure the voltage across the transmitter power terminals does not drop below 12.0 Vdc. Verify that the operating atmosphere of the transmitter is consistent with the appropriate hazardous locations certifications. Always use extreme caution when making contact with the leads and terminals.

If the sensor is installed in a high-voltage environment and a fault condition or installation error occurs, the sensor leads and transmitter terminals could carry lethal voltages. Use extreme caution when making contact with the leads and terminals.

⚠ CAUTION

Do not apply high voltage (e.g., ac line voltage) to the transmitter terminals since high voltage can damage the unit. (Sensor and transmitter power terminals are rated up to 42.4 Vdc.) Use extreme caution when making contact with the leads and terminals.

For multichannel installations, see [Multichannel installations](#). The transmitters accept inputs from a variety of RTD and thermocouple types. Refer to [Figure 2-10](#) when making sensor connections.

Use the following steps to wire the transmitter:

Procedure

1. Remove the terminal block cover (if applicable).
2. Connect the positive power lead to the “+” terminal. Connect the negative power lead to the “-” terminal (see [Figure 2-9](#)). Use extreme caution when making contact with the leads and terminals.
3. Tighten the terminal screws.
4. Reattach and tighten the cover (if applicable). All connection head covers must be fully engaged to meet explosion-proof requirements.
5. Apply power (see [Power supply](#)).

Figure 2-9: Rosemount 248 wiring

Power, communication, and sensor terminals

Connecting a communicator to a transmitter loop

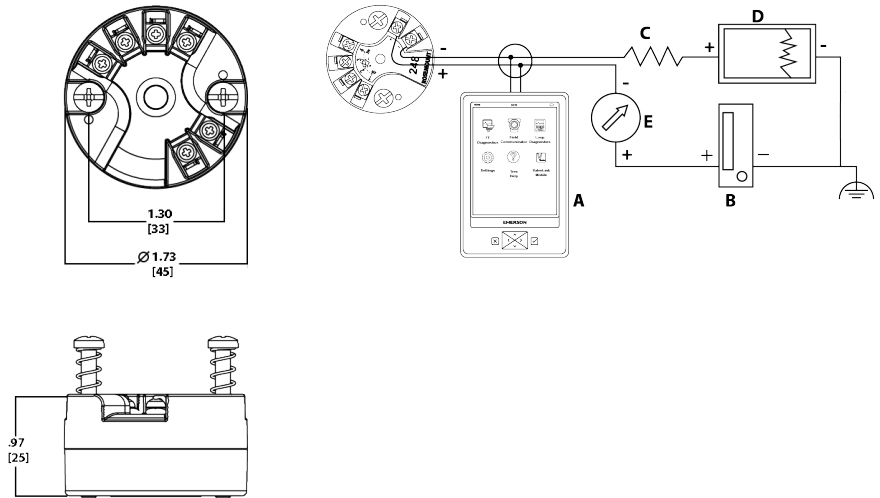

- A. Field communicator
- B. Power supply
- C. $250 V \leq R_L \leq 1100 V$
- D. Recorder (optional)
- E. Ammeter (optional)

Note

Signal loop may be grounded at any single point or left ungrounded.

Note

A Field Communicator may be connected at any termination point in the signal loop. The signal loop must have between 250 and 1100 ohms load for communications.

2.9.1 Sensor connections

The Rosemount 248 is compatible with a number of RTD and thermocouple sensor types. [Figure 2-10](#) shows the correct input connections to the sensor terminals on the transmitter. To ensure proper sensor connection, anchor the sensor lead wires to the appropriate compression terminals and tighten the screws. Use extreme caution when making contact with the leads and terminals.

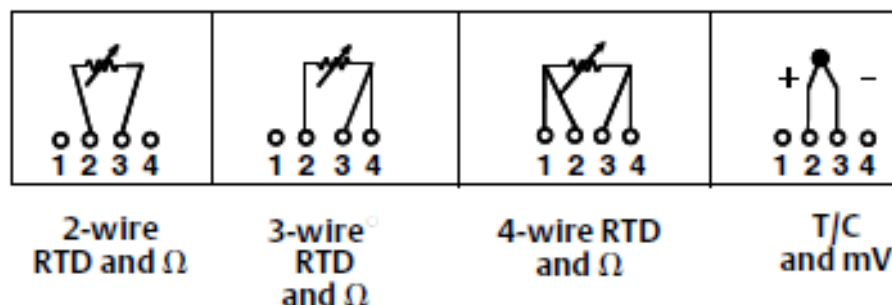
Figure 2-10: Sensor Wiring Diagrams

Thermocouple or millivolt inputs

The thermocouple can be connected directly to the transmitter. Use appropriate thermocouple extension wire if mounting the transmitter remotely from the sensor. Make millivolt input connections with copper wire, and use shielding for long runs of wire.

RTD or ohm inputs

The transmitters accept a variety of RTD configurations, including 2-, 3-, and 4-wire designs. If the transmitter is mounted remotely from a 3- or 4-wire RTD, it will operate within specifications, without recalibration, for lead wire resistances up to 60 ohms per lead (or the equivalent to 6,000 ft. of 20 AWG wire). In this case, the leads between the RTD and transmitter should be shielded. If using only two leads, the RTD leads are in series with the sensor element, so significant errors can occur when the lead lengths exceed three feet of 20 AWG wire (approximately 9.8436 °F/ft [0.05 °C/ft]). For longer runs, attach a third or fourth lead, as described above.

Sensor lead wire resistance effect– RTD input

When using a 4-wire RTD, the effect of lead resistance is eliminated and does not impact accuracy. A 3-wire sensor will not fully cancel lead resistance error since it cannot compensate for imbalances in resistance between the lead wires. Using the same type of wire on all three lead wires makes a 3-wire RTD installation the most accurate. A 2-wire sensor produces the largest error since it directly adds the lead wire resistance to the sensor resistance. For 2- and 3-wire RTDs, an additional lead wire resistance error is induced with ambient temperature variations. The table and the examples shown on [Table 2-1](#) help quantify these errors.

Table 2-1: Examples of Approximate Basic Error

Sensor input	Approximate basic error
4-wire RTD	None (independent of lead wire resistance)
3-wire RTD	$\pm 1.0 \Omega$ in reading per ohm of unbalanced lead wire resistance (Unbalanced lead wire resistance = maximum imbalance between any two leads.)
2-wire RTD	1.0 Ω in reading per ohm of lead wire resistance

Examples of approximate lead wire resistance effect calculations

Given:

Total cable length:	150 m
Imbalance of the lead wires at 20 °C:	0.5 Ω
Resistance/length (18 AWG Cu):	0.025 Ω/m °C
Temperature coefficient of Cu (α_{Cu}):	0.039 Ω/Ω °C
Temperature coefficient of Pt (α_{Pt}):	0.00385 Ω/Ω °C
Change in Ambient Temperature (ΔT_{amb}):	25 °C
RTD Resistance at 0 °C (R_0):	100 Ω (for Pt 100 RTD)

- Pt100 4-wire RTD: No lead wire resistance effect.
- Pt100 3-wire RTD:

$$\text{Basic Error} = \frac{\text{Imbalance of Lead Wires}}{(\alpha_{Pt} \times R_0)}$$

$$\text{Error due to amb. temp. variation} = \frac{(\alpha_{Cu}) \times (\Delta T_{amb}) \times (\text{Imbalance of Lead Wires})}{(\alpha_{Pt}) \times (R_0)}$$

Lead wire imbalance seen by the transmitter = 0.5 Ω

$$\text{Basic error} = \frac{0.5 \Omega}{(0.00385 \Omega / \Omega \text{ } ^\circ\text{C}) \times (100 \Omega)} = 1.3 \text{ } ^\circ\text{C}$$

Error due to amb. temp. var. of ± 25 °C

$$= \frac{(0.0039 \Omega / \Omega \text{ } ^\circ\text{C}) \times (25 \text{ } ^\circ\text{C}) \times (0.5 \Omega)}{(0.00385 \Omega / \Omega \text{ } ^\circ\text{C}) \times (100 \Omega)} = \pm 0.13 \text{ } ^\circ\text{C}$$

- Pt100 2-wire RTD:

$$\text{Basic Error} = \frac{\text{Lead Wire Resistance}}{(\alpha_{Pt} \times R_0)}$$

$$\text{Error due to amb. temp. variation} = \frac{(\alpha_{Cu}) \times (\Delta T_{amb}) \times (\text{Lead Wire Resistance})}{(\alpha_{Pt}) \times (R_0)}$$

Lead wire resistance seen by the transmitter = 150 m × 2 wires × 0.025 Ω/m = 7.5 Ω

$$\text{Basic error} = \frac{7.5 \Omega}{(0.00385 \Omega / \Omega \text{ } ^\circ\text{C}) \times (100 \Omega)} = 19.5 \text{ } ^\circ\text{C}$$

Error due to amb. temp. var. of ± 25 °C

$$= \frac{(0.0039 \Omega / \Omega \text{ } ^\circ\text{C}) \times (25 \text{ } ^\circ\text{C}) \times (7.5 \Omega)}{(0.00385 \Omega / \Omega \text{ } ^\circ\text{C}) \times (100 \Omega)} = \pm 1.9 \text{ } ^\circ\text{C}$$

2.10 Power supply

To communicate with a transmitter, an 18.1 Vdc minimum power supply is required. The power supplied to the transmitter should not drop below the transmitter lift-off voltage (see [Figure 2-11](#)). If the power drops below the lift-off voltage while the transmitter is being configured, configuration may be interrupted.

The dc power supply should provide power with less than two percent ripple. The total resistance load is the sum of the resistance of the signal leads and the load resistance of any controller, indicator, or related pieces of equipment in the loop. Note that the resistance of intrinsic safety barriers, if used, must be included.

Figure 2-11: Load Limits

$$\text{Maximum load} = 40.8 \times (\text{Supply voltage} - 12.0)$$

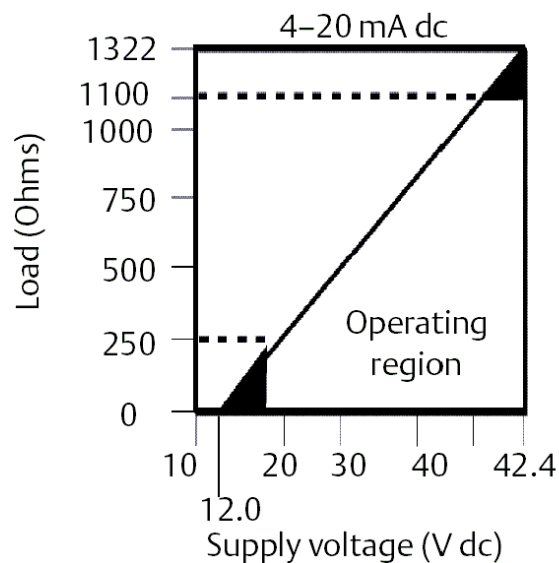

2.10.1 Surges/transients

The transmitter will withstand electrical transients of the energy level encountered in static discharges or induced switching transients. However, high-energy transients, such as those induced in wiring from nearby lightning strikes, welding, heavy electrical equipment, or switching gears, can damage both the transmitter and the sensor.

2.10.2 Ground the transmitter

The transmitter operates with the current signal loop either floating or grounded. However, extra noise in floating systems may affect many types of readout devices. If the signal appears noisy or erratic, grounding the current signal loop at a single point may solve the problem. The best place to ground the loop is at the negative terminal of the power supply. Do not ground the current signal loop at more than one point.

The transmitter is electrically isolated to 500 Vac rms (707 Vdc), so the input circuit may also be grounded at any single point. When using a grounded thermocouple, the grounded junction serves as this point.

Note

Do not ground the signal wire at both ends.

Ungrounded thermocouple, mV, and RTD/ohm inputs

Each process installation has different requirements for grounding. Use the grounding options recommended by the facility for the specific sensor type, or begin with grounding option one (the most common).

Grounding the transmitter (option one)

Procedure

1. Connect sensor wiring shield to the transmitter housing (only if the housing is grounded).
 2. Ensure the sensor shield is electrically isolated from surrounding fixtures that may be grounded.
 3. Ground signal wiring shield at the power supply end.
-

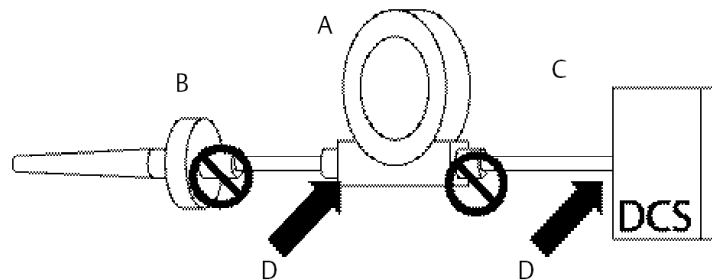

- A. Transmitter
 - B. Sensor wires
 - C. DCS host system
 - D. Shield ground point
-

Grounding the transmitter (option two for ungrounded housing)

Procedure

1. Connect signal wiring shield to the sensor wiring shield.
2. Ensures the two shields are tied together and electrically isolated from the transmitter housing.
3. Ground shield at the power supply end only.
4. Ensure that the sensor shield is electrically isolated from the surrounding grounded fixtures.

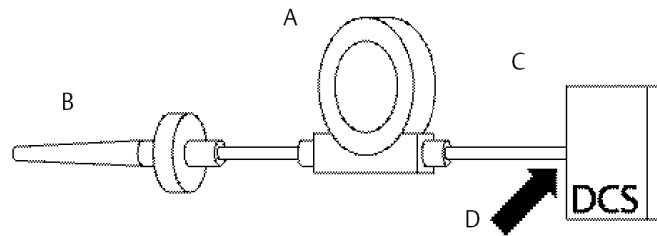

Connect shields together, electrically isolated from the transmitter

- A. Transmitter
- B. Sensor wires
- C. DCS host system
- D. Shield ground point

Grounding the transmitter (option three)

Procedure

1. Ground sensor wiring shield at the sensor, if possible.
2. Ensure the sensor wiring and signal wiring shields are electrically isolated from the transmitter housing.
3. Do not connect the signal wiring shield to the sensor wiring shield.
4. Ground signal wiring shield at the power supply end.

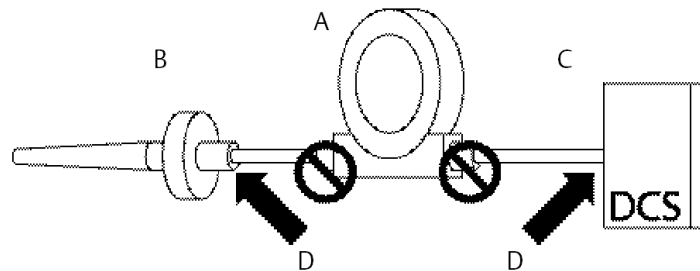

- A. Transmitter
- B. Sensor wires
- C. DCS host system
- D. Shield ground point

Grounding the transmitter (option four: thermocouple inputs)

Procedure

1. Ground sensor wiring shield at the sensor.
 2. Ensure the sensor wiring and signal wiring shields are electrically isolated from the transmitter housing.
 3. Do not connect the signal wiring shield to the sensor wiring shield.
 4. Ground signal wiring shield at the power supply end.
-

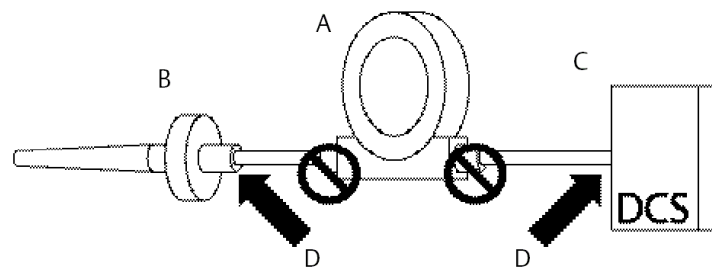

- A. Transmitter
 - B. Sensor wires
 - C. DCS host system
 - D. Shield ground point
-

3 Configuration

3.1 Safety messages

Instructions and procedures in this section may require special precautions to ensure the safety of the personnel performing the operations. Information that potentially raises safety issues is indicated by a warning symbol (⚠). Please refer to the following safety messages before performing an operation preceded by this symbol.

⚠ WARNING

Failure to follow these installation guidelines could result in death or serious injury.

Ensure only qualified personnel perform the installation.

Explosions could result in death or serious injury.

Do not remove the housing covers in explosive atmospheres when the circuit is live. Before connecting a handheld communicator in an explosive atmosphere, ensure the instruments are installed in accordance with intrinsically safe or non-incendive field wiring practices.

Verify that the operating atmosphere of the transmitter is consistent with the appropriate hazardous locations certifications.

All connection head covers must be fully engaged to meet explosion-proof requirements.

Process leaks could result in death or serious injury.

Do not remove the thermowell while in operation.

Install and tighten thermowells and sensors before applying pressure.

Electrical shock could cause death or serious injury.

Use extreme caution when making contact with the leads and terminals.

3.2 Commissioning

The Rosemount™ 248 Temperature Transmitter must be configured for certain basic variables to operate. In many cases, all of these variables are pre-configured at the factory. Configuration may be required if the transmitter is not configured or if the configuration variables need to be revised.

Commissioning consists of testing the transmitter and verifying transmitter configuration data. The Rosemount 248 can be commissioned before (off-line) or after (on-line) installation. During on-line configuration, the transmitter is connected to a Field Communicator and data is entered into the working register of the communicator and sent directly to the transmitter. Off-line configuration consists of storing configuration data in a Field Communicator while it is not connected to a transmitter. Data is stored in nonvolatile memory and can be downloaded to the transmitter at a later time.

Commissioning the transmitter on the bench before installation using a Field Communicator or AMS Suite: Intelligent Device Manager ensures that all transmitter components are working.

To commission on the bench, connect the transmitter and the Field Communicator (or AMS Device Manager) as shown in [Figure 2-9](#) and [Figure 2-10](#). Make sure the instruments in the loop are installed according to intrinsically-safe or non-incendive field wiring practices before connecting in an explosive atmosphere. Connect Field Communicator or AMS Device Manager leads at any termination point in the signal loop. Connect the communication leads to the “COMM” terminals located on the terminal block. Do not connect to the “TEST” terminals. Then set the transmitter jumpers to avoid damage caused by the plant environment.

3.2.1 Setting the loop to manual

When sending or requesting data that could disrupt the loop or change the output of the transmitter, set the process application loop to manual. The Field Communicator will prompt to set the loop to manual when necessary. Acknowledging this prompt does not set the loop to manual, it is only a reminder. Setting the loop to manual is a separate operation.

3.3 AMS Device Manager

One of the key benefits of intelligent devices is the ease of device configuration. When used with AMS Device Manager, the Rosemount 248 is easily configured and provides instant and accurate alerts and alarms. The screens use a color-coding for a visual indication of the transmitter health, and to indicate any changes that may need to be made or written to the transmitter.

- Gray screens: indicates that all information has been written to the transmitter
- Yellow on screen: changes have been made in the software but not sent to the transmitter
- Green on screen: all current changes on screen have been written to the transmitter
- Red on screen: indicates an alarm or alert that requires immediate investigation

3.3.1 Apply AMS Device Manager changes

Procedure

1. Right click on the device and select **Configuration Properties** from the menu.
2. From the bottom of the screen, select **Apply**.
3. When the Apply Parameter Modification screen appears, enter the desired information and select **OK**.
4. After reading the warning provided, select **OK**.

3.4 Field Communicator

The Field Communicator exchanges information with the transmitter from the control room, the instrument site, or any wiring termination point in the loop. To assist communication, connect the Field Communicator in parallel with the transmitter, as shown in [Figure 2-9](#). Use the loop connection ports, which are non-polarized, on the rear panel of the Field Communicator. Do not make connections to the serial port of the nickel-cadmium (NICAad) recharger jack in explosive atmospheres. To use the Field Communicator in an explosive atmosphere, the instruments in the loop should be installed according to intrinsically safe or non-incendive field wiring practices.

When using a Field Communicator, configuration changes must be sent to the transmitter using the “Send” key (F2).

For more information regarding the Field Communicator, see the [Field Communicator User Guide](#).

3.4.2 HART® 7 menu tree

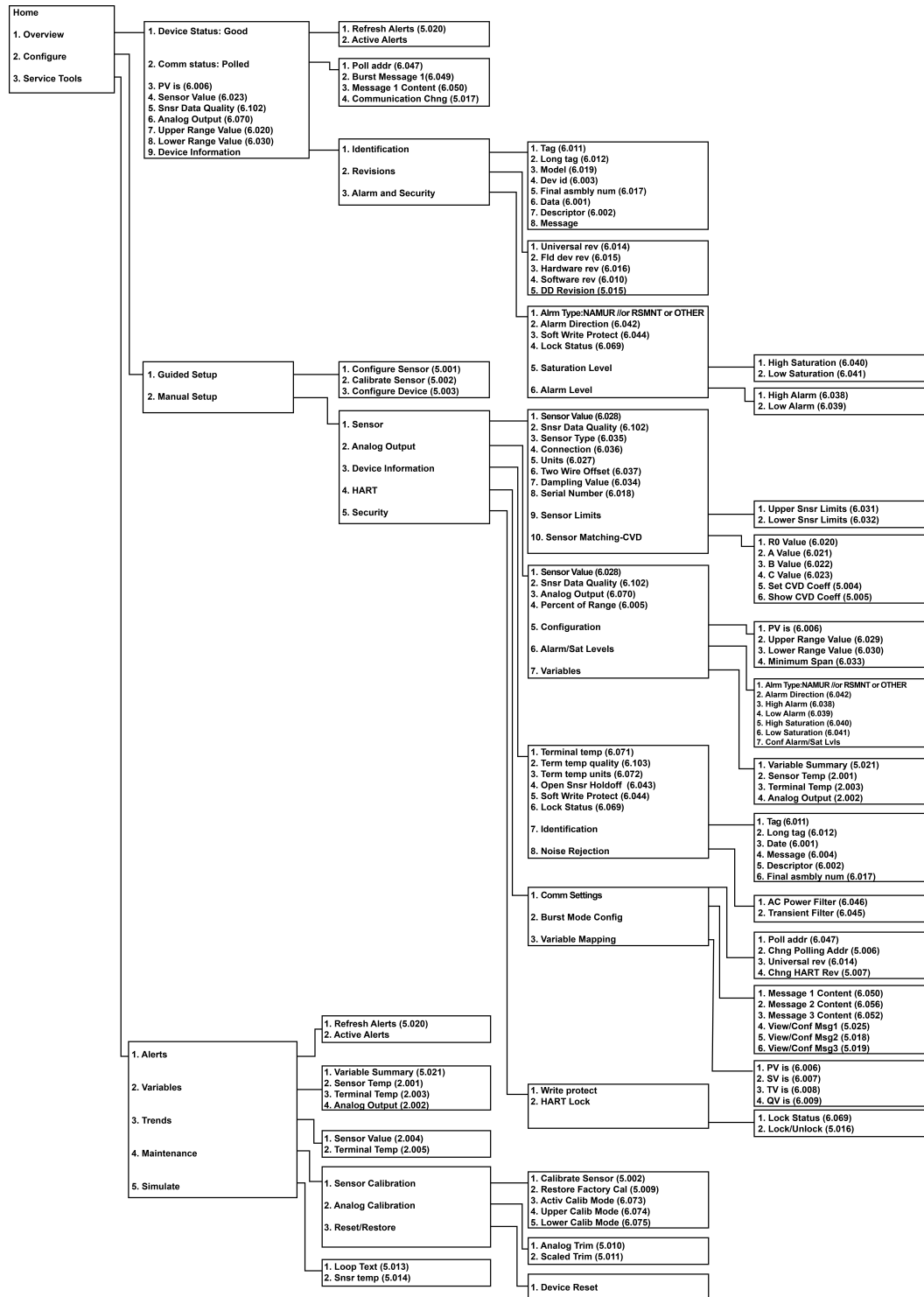

3.4.3 Review configuration data

Before operating the transmitter in an actual installation, review all of the factory-set configuration data to be sure that it reflects the current application.

When activating the Review function, scroll through the configuration data list to check each process variable. If changes to the transmitter configuration data are necessary, refer to [Configuring the transmitter](#) below.

3.4.4 Check output

Before performing other transmitter on-line operations, review the Rosemount™ 248 digital output parameters to be sure that the transmitter is operating properly.

The Process Variables menu displays continuously updated process variables, including sensor temperature, percent of range, analog output, and terminal temperature. The primary variable is the 4–20 mA analog signal. The secondary variable is the transmitter terminal temperature.

3.4.5 Configuring the transmitter

The transmitter must be configured for certain basic variables to be operational. In many cases, these variables are pre-configured at the factory. Configuration may be required if the transmitter is not configured, or if the configuration variables need revision.

Variable mapping

The Variable Mapping menu displays the sequence of the process variables. When using the Rosemount 248 5 Variable Re-Map can be selected to change this configuration. When the Select PV screen appears Snsr 1 must be selected. Either Sensor 1, Terminal Temperature, or not used can be selected for the remaining variables. The primary variable is the 4–20 mA analog signal.

Select sensor type

The **Connections** command allows selection of the sensor type and the number of sensor wires to be connected. Select from the following sensors:

- 2-, 3-, or 4-wire Pt 100, Pt 200, Pt 500, Pt 1000 RTDs: $\alpha = 0.00385 \Omega/^\circ\text{C}$
- 2-, 3-, or 4-wire Pt 100, Pt 200 (HART 7 only): $\alpha = 0.003916 \Omega/^\circ\text{C}$
- 2-, 3-, or 4-wire Ni 120 nickel RTDs
- 2-, 3-, or 4-wire Cu 10 RTDs
- IEC/NIST/DIN Type B, E, J, K, R, S, T thermocouples
- DIN type L, U thermocouples
- ASTM Type W5Re/W26Re thermocouple
- –10 to 100 millivolts
- 2-, 3-, or 4-wire 0 to 2000 ohms

A complete line of temperature sensors, thermowells, and accessory mounting hardware is available from Emerson.

Set output units

The **Set Output Unit** command establishes the desired primary variable units. The transmitter output can be set to one of the following engineering units:

- Degrees Celsius
- Degrees Fahrenheit
- Degrees Rankine
- Kelvin
- Ohms
- Millivolts

50/60 Hz filter

The **50/60 Hz Filter** command sets the transmitter electronic filter to reject the AC power supply frequency in the plant.

Terminal temperature

The **Terminal Temp** command sets the terminal temperature units to indicate the temperature at the transmitter terminals.

Process Variable (PV) damping

The **PV Damp** command changes the response time of the transmitter to smooth variations in output readings caused by rapid changes in input. Determine the damping setting based on the necessary response time, signal stability, and other requirements of the loop dynamics of the system. The default damping value is 5.0 seconds and can be reset to any value between zero and 32 seconds.

The damping value chosen affects the response time of the transmitter. When it is set to zero (or disabled), the damping function is off and the transmitter output reacts to changes in input as quickly as the intermittent sensor algorithm allows (refer to [Intermittent threshold](#)) for a description of the intermittent sensor algorithm). Increasing the damping value increases the transmitter response time.

With damping enabled, the transmitter outputs values according to the following relationship.

$$\text{Damping value} = P + (N - P) \times \left(1 - e^{-\frac{t}{T}} \right)$$

P = previous damped value
 N = new sensor value
 T = damping time constant
 U = update rate

At the time the damping time constant is set, the transmitter output is at 63 percent of the input change and continues to approach the input according to the damping equation above.

After one damping time constant following a sensor input step change, the transmitter output will be at 63.2 percent of that change. The output continues to approach the input according to the damping equation above.

For example, as illustrated in [Figure 3-1](#), if the temperature undergoes a step change from 100 degrees to 110 degrees, and the damping is set to 5.0 seconds, the transmitter calculates and reports a new reading using the damping equation. At 5.0 seconds, the transmitter outputs 106.3 degrees, or 63.2 percent of the input change, and the output continues to approach the input curve according to the equation above.

Figure 3-1: Change in Input vs. Change in Output with Damping Set to Five Seconds

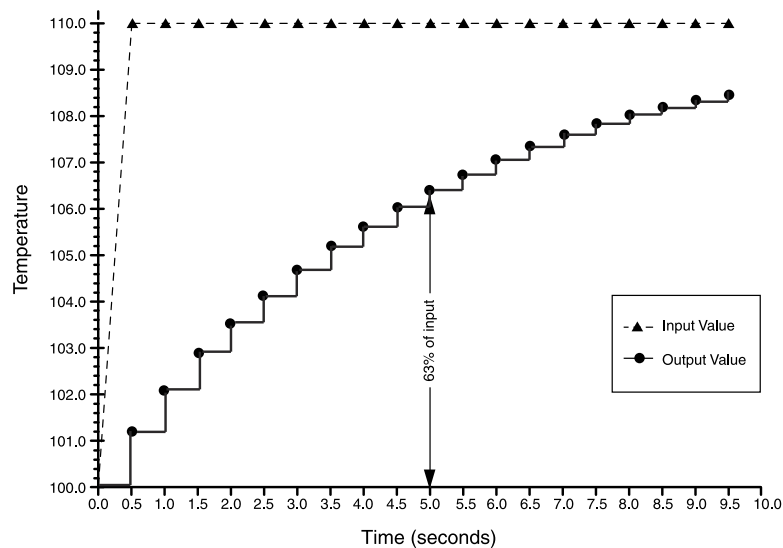

2-wire RTD offset

The 2-wire RTD Offset command allows the user to input the measured lead wire resistance, which results in the transmitter adjusting its temperature measurement to correct the error caused by this resistance. Due to a lack of lead wire compensation within the RTD, temperature measurements made with a 2-wire RTD are often inaccurate. See [RTD or ohm inputs](#) for more information.

To utilize this feature:

Procedure

1. Measure the lead wire resistance of both RTD leads after installing the 2-wire RTD and the Rosemount 248.
2. From the HOME screen, select **1 Device Setup, 3 Configuration, 2 Sensor Configuration, 1 Sensor 1, 2 Snsr 1 Setup, and 1 2-Wire Offset**.
3. Enter the total measured resistance of the two RTD leads at the 2-Wire Offset prompt. Enter this resistance as a negative (-) value to ensure proper adjustment. The transmitter adjusts its temperature measurement to correct the error caused by lead wire resistance.

3.4.6 Information variables

Access the transmitter information variables on-line using the Field Communicator or other suitable communications device. Following is a list of transmitter information variables which include device identifiers, factory-set configuration variables, and other information. A description of each variable and a review of its purposes are provided.

Tag

The **Tag** variable is the easiest way to identify and distinguish between transmitters in multi-transmitter environments. Use it to label transmitters electronically according to the requirements of the application. The Tag defined is automatically displayed when a HART-based Communicator establishes contact with the transmitter at power-up. The Tag may be up to eight characters long and has no impact on the primary variable readings of the transmitter.

Long Tag

The Long Tag is similar to Tag. The Long Tag is different in that the Long Tag can be up to 32 characters instead of the eight characters in traditional Tag.

Date

The **Date** command is a user-defined variable that provides a place to save the date of the last revision of configuration information. It has no impact on the operation of the transmitter or the Field Communicator.

Descriptor

The **Descriptor** variable provides a longer user-defined electronic label to assist with more specific transmitter identification than is available with the Tag variable. The Descriptor may be up to 16 characters long and has no impact on the operation of the transmitter or the Field Communicator.

Message

The **Message** variable provides the most specific user-defined means for identifying individual transmitters in multi-transmitter environments. It allows for 32 characters of information and is stored with the other configuration data. The Message variable has no impact on the operation of the transmitter or the Field Communicator.

Sensor serial number

The **Sensor S/N** variable provides a location to list the serial number of the attached sensor. It is useful for identifying sensors and tracking sensor calibration information.

3.4.7 Diagnostics and service

Test device

The **Test Device** command initiates a more extensive diagnostics routine than is performed continuously by the transmitter. The **Test Device** menu lists the following options:

- **1 Loop test** verifies the output of the transmitter, the integrity of the loop, and the operations of any recorders or similar devices installed in the loop. See [Loop test](#) below for more information.
- **2 Self Test** initiates a transmitter self test. Error codes are displayed if there is a problem.
- **3 Master Reset** sends out a command that restarts and tests the transmitter. A master reset is like briefly powering down the transmitter. Configuration data remains unchanged after a master reset.
- **4 Status** lists error codes. `On` indicates a problem, and `Off` means there are no problems.

Loop test

The **Loop Test** command verifies the output of the transmitter, the integrity of the loop, and the operations of any recorders or similar devices installed in the loop. To initiate a loop test, perform the following procedure:

Procedure

1. Connect a reference meter to the transmitter. To do so, shunt the transmitter power through the meter at some point in the loop.
2. From the `Home` screen, choose **1 Device Setup, 2 Diag/Serv, 1 Test Device, 1 Loop Test** before performing a loop test.
3. Choose a discreet milliampere level for the transmitter to output. At the `Choose analog output` prompt, choose **1 4mA, 2 20mA**, or choose **3 other** to manually input a value between 4 and 20 mA.
4. Check the current meter installed in the test loop to verify that it reads the value that was commanded to output. If the readings do not match, either the transmitter requires an output trim or the current meter is malfunctioning.

After completing the test procedure, the display returns to the loop test screen and another output value can be chosen.

Master Reset

Master Reset resets the electronics without actually powering down the unit. It does not return the transmitter to the original factory configuration.

Active Calibrator Mode

The Active Calibrator Mode command enables or disables the pulsating current feature. The transmitter ordinarily operates with pulsating current so that sensor diagnostic functions, such as open sensor detection and EMF compensation, can be performed correctly. Some calibration equipment requires steady current to function properly. By enabling the Active Calibrator Mode the transmitter stops sending pulsating current to the sensor and supplies a steady current. Disabling the Active Calibrator Mode returns the transmitter to the normal operating state where it sends a pulsating current to the sensor, enabling the sensor diagnostic functions.

The Active Calibrator Mode is volatile and is automatically disabled when power is cycled, or when a Master Reset is performed using the Field Communicator.

Note

The Active Calibrator Mode must be disabled before returning the transmitter to the process to ensure that the full diagnostic capabilities of the Rosemount 248 are available. Disabling or enabling the Active Calibrator Mode will not change any of the sensor trim values stored in the transmitter.

Sensor Condition

The **Signal Condition** command allows viewing or changing of the primary variable lower and upper range values, sensor percent of range, and sensor damping.

Write Protect

The **Write Protect** command protects the transmitter configuration data from accidental or unwarranted changes. To enable the write protect feature:

Procedure

1. From the *HOME* screen select **1 Device Setup, 2 Diag/Service, 3 Write Protect**.
2. Select **Enable WP**.

Note

To disable write protect on the Rosemount 248, repeat the procedure, replacing **Enable WP** with **Disable WP**.

HART Output

The **HART Output** command allows the user to make changes to the multidrop address, initiate burst mode, or make changes to the burst options.

Alarm/Saturation

The Alarm/Saturation command allows the alarm settings (Hi or Low) and saturation values to be viewed and changed. To change the alarm values and saturation values, select the value to be changed, either 2 Low Alarm, 3 High Alarm, 4 Low Sat., or 5 High Sat then enter the desired new value, which must fall within the guidelines:

- The low alarm value must be between 3.50 and 3.75 mA
- The high alarm value must be between 21.0 and 23.0 mA

- The low saturation level must be between the low alarm value plus 0.1 mA and 3.9 mA (minimum of 3.7 mA).

Example: The low alarm value has been set to 3.7 mA. Therefore, the low saturation level, S , must be $3.8 \leq S \leq 3.9$ mA.

- The high saturation level must be between 20.5 mA and 20.9 mA.

See [Failure mode](#) for Failure Mode considerations.

Rerange

Reranging the transmitter sets the measurement range to the limits of expected readings which maximizes transmitter performance; the readings are most accurate when the transmitter is operated within the expected temperature range for the application.

PV range values

The **PV URV** and **PV LRV** commands, found on the PV Range Values menu screen, allow the user to set the transmitter's lower and upper range values using limits of expected readings. The range of expected readings is defined by the Lower Range Value (LRV) and Upper Range Value (URV). The transmitter range values can be reset as often as necessary to reflect changing process conditions. From the PV Range Values screen select 1 PV LRV to change the lower range value and 2 PV URV to change the upper range value.

Note

The rerange functions should not be confused with the trim functions. Although the rerange command matches a sensor input to a 4–20 mA output, as in conventional calibration, it does not affect the transmitter's interpretation of the input.

Intermittent sensor detect (advanced feature)

The Intermittent Sensor Detect feature guards against process temperature readings caused by intermittent open sensor conditions (an **intermittent** sensor condition is an open sensor condition that lasts less than one update). By default, the transmitter is shipped with the intermittent sensor detect feature switched **ON** and the threshold value set to 0.2 percent of sensor limits. The Intermittent Sensor Detect feature can be switched **ON** or **OFF** and the threshold value can be changed to any value between 0 and 100 percent of the sensor limits with a Field Communicator.

Transmitter behavior with intermittent sensor detect ON

When the Intermittent Sensor Detect feature is switched **ON**, the transmitter can eliminate the output pulse caused by intermittent open sensor conditions. Process temperature changes (ΔT) within the threshold value are tracked normally by the transmitter's output. A ΔT greater than the threshold value activates the intermittent sensor algorithm. True open sensor conditions cause the transmitter to go into alarm.

The threshold value of the Rosemount 248 should be set at a level allowing for normal range of process temperature fluctuations; too high and the algorithm will not be able to filter out intermittent conditions; too low and the algorithm will be activated unnecessarily. The default threshold value is 0.2 percent of the sensor limits.

Transmitter behavior with intermittent sensor detect OFF

When the Intermittent Sensor Detect feature is switched OFF, the transmitter tracks all process temperature changes, even if they are the result of an intermittent sensor. (The transmitter behaves as though the threshold value had been set at 100 percent.) The output delay because of the intermittent sensor algorithm will be eliminated.

Intermittent threshold

The threshold value can be changed from the default value of 0.2 percent. Turning the Intermittent Sensor Detect feature OFF or leaving it ON and increasing the threshold value above the default does not affect the time needed for the transmitter to output the correct alarm signal after detecting a true open sensor condition. However, the transmitter may briefly output a false temperature reading for up to one update in either direction (see Figure 3-3) up to the threshold value (100 percent of sensor limits if Intermittent Sensor Detect is OFF). Unless rapid response rate is necessary, the suggested setting of the Intermittent Sensor Detect mechanism is ON with 0.2 percent threshold.

Figure 3-2: Open Sensor Response

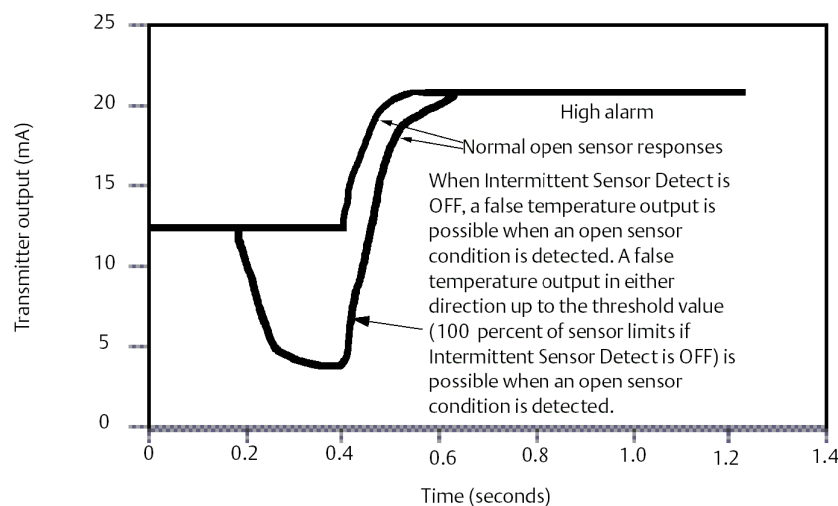

Open sensor holdoff

The Open Sensor Holdoff option, at the normal setting, enables the Rosemount 248 to tolerate heavy EMI disturbances without producing brief periods of alarm. This is accomplished through the software by having the transmitter perform additional verification of the open sensor status prior to activating the transmitter alarm. If the additional verification shows that the open sensor condition is not valid, the transmitter will not go into alarm.

For users of the Rosemount 248 that desire a more immediate open sensor detection, the Open Sensor Holdoff option can be changed to a fast setting. On this setting, the transmitter reports an open sensor condition without additional verification of the open condition.

3.5 Multidrop communication

Multidropping refers to the connection of several transmitters to a single communications transmission line. Communication between the host and the transmitters takes place digitally with the analog output of the transmitters deactivated.

Many Rosemount transmitters can be multidropped. With the HART communications protocol, up to 15 transmitters can be connected on a single twisted pair of wires or over leased phone lines.

A Field Communicator can test, configure, and format a multidropped Rosemount 248 Transmitter in the same way as in a standard point-to-point installation.

The application of a multidrop installation requires consideration of the update rate necessary from each transmitter, the combination of transmitter models, and the length of the transmission line. Each transmitter is identified by a unique address (1–15) and responds to the commands defined in the HART protocol.

Figure 3-3: Typical Multidropped Network

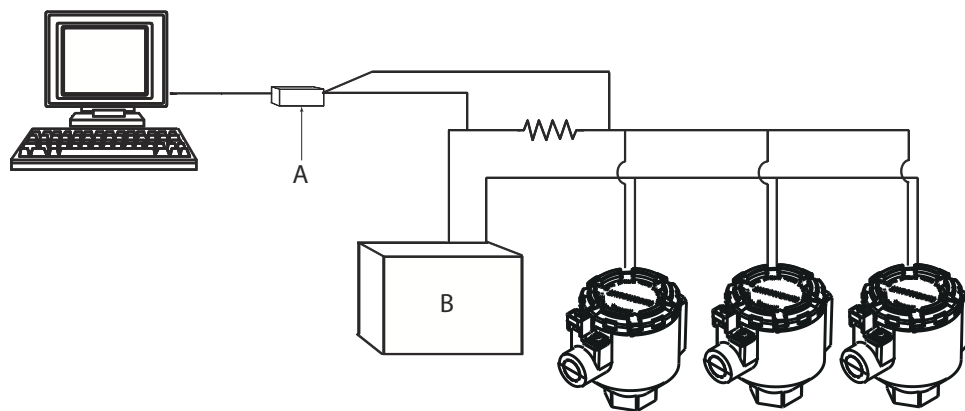

- A. Rosemount 248 HART transmitter
- B. Power supply

Figure 3-3 shows a typical multidrop network. Do not use this figure as an installation diagram. Contact Emerson product support with specific requirements for multidrop applications.

Note

Rosemount 248 Transmitters are set to address 0 at the factory, which allows them to operate in the standard point-to-point manner with a 4–20 mA output signal. To activate multidrop communication, the transmitter address must be changed to a number between 1 and 15. This change deactivates the 4–20 mA analog output and sets it to 4 mA and disables the current failure mode.

3.6 Rosemount 248 Configuration Interface specifications

3.6.1 Configuration software (HART 5 only)

The Rosemount 248 PC-based configuration software for the Rosemount™ 248 allows comprehensive configuration of the transmitters. Used in conjunction with various Rosemount or user-supplied hardware modems, the software provides the tools necessary to configure the Rosemount 248 transmitters including the following parameters:

- Process Variable
- Sensor Type
- Number of Wires
- Engineering Units
- Transmitter Tag Information
- Damping
- Alarming Parameters

3.6.2 Configuration hardware

The Rosemount 248 Configuration Interface has three hardware options as follows:

Software only

Customer must provide appropriate communications hardware (modem, power supply, etc.)

Serial HART modem and software

Serial HART modem. Customer must provide separate loop power supply and resistor. Requires PC serial port. Suitable for use with powered loops.

USB HART modem and software

USB (Universal Serial Bus) HART modem. Customer must provide separate loop power supply and resistor. Requires PC with USB port. Suitable for use with powered loops.

3.6.3 Rosemount 248 PC Programmer Kit installation (HART 5 Only)

Procedure

1. Install all necessary software for Rosemount 248 PC configuration:
 - a) Install the Rosemount 248 Programming software
 - Place the 248 Programming CD-ROM in the drive.
 - Run setup.exe from Windows™ XP, 7, 8, or 10.

- b) Install the MACTek® HART Modem drivers completely before beginning bench configuration with the Rosemount 248 PC Programming system.

Note

For USB modem: Upon first use, configure appropriate COM ports within the Rosemount 248PC software by choosing Port Settings from the Communicate menu. The USB modem driver emulates a COM port and will add to available port selections in the software's drop-down box. Otherwise software defaults to first available COM port, which may not be correct.

- 2. Set up configuration system hardware:
 - a) Hook up the transmitter and load resistor (250–1100 ohms) wired in series with the power supply. (The Rosemount 248 device will need an external power supply of 12–42.4 Vdc for configuration).
 - b) Attach the HART Modem in parallel with the load resistor and connect it to the PC.

Example

See [Table 3-1](#) for spares kit and re-order numbers.

Table 3-1: Rosemount 248 Programming Kit Spare Part Numbers

Product description	Part number
Programming Software (CD)	00248-1603-0002
Rosemount 248 Programmer Kit - USB	00248-1603-0003
Rosemount 248 Programmer Kit - Serial	00248-1603-0004

4 Operation and maintenance

4.1 Safety messages

Instructions and procedures in this section may require special precautions to ensure the safety of the personnel performing the operations. Information that potentially raises safety issues is indicated by a warning symbol (⚠). Please refer to the following safety messages before performing an operation preceded by this symbol.

⚠ WARNING

Failure to follow these installation guidelines could result in death or serious injury.

Ensure only qualified personnel perform the installation.

Explosions could result in death or serious injury.

Do not remove the housing covers in explosive atmospheres when the circuit is live. Before connecting a handheld communicator in an explosive atmosphere, ensure the instruments are installed in accordance with intrinsically safe or non-incendive field wiring practices.

Verify that the operating atmosphere of the transmitter is consistent with the appropriate hazardous locations certifications.

All connection head covers must be fully engaged to meet explosion-proof requirements.

Process leaks could result in death or serious injury.

Do not remove the thermowell while in operation.

Install and tighten thermowells and sensors before applying pressure.

Electrical shock could cause death or serious injury.

Use extreme caution when making contact with the leads and terminals.

4.2 Calibration

Calibrating the transmitter increases measurement precision by allowing corrections to be made to the factory-stored characterization curve by digitally altering the transmitter's interpretation of the sensor input.

To understand calibration, it is necessary to realize that smart transmitters operate differently from analog transmitters. An important difference being that smart transmitters are factory-characterized, meaning they are shipped with a standard sensor curve stored in the transmitter firmware. In operation, the transmitter uses this information to produce a process variable output, in engineering units, dependent on the sensor input.

Calibration of the Rosemount 248 may include the following procedures:

- Sensor Input Trim: digitally alter the transmitter's interpretation of the input signal
- Transmitter-sensor matching: generates a special custom curve to match that specific sensor curve, as derived from the Callendar-Van Dusen (CVD) constants
- Output Trim: calibrates the transmitter to a 4–20 mA reference scale
- Scaled Output Trim: calibrates the transmitter to a user-selectable reference scale.

4.2.1 Trim the transmitter

One or more of the trim functions may be used when calibrating. The trim functions are as follows:

- Sensor input trim
- Transmitter-sensor matching
- Output trim
- Output scaled trim

Sensor input trim

Perform a sensor trim if the transmitters digital value for the primary variable does not match the plant's standard calibration equipment. The sensor trim function calibrates the sensor to the transmitter in temperature units or raw units. Unless your site-standard input source is NIST-traceable, the trim functions will not maintain the NIST-traceability of the system.

The **Sensor Input Trim** command allows the transmitter's interpretation of the input signal to be digitally altered (see [Figure 4-1](#)). The sensor input calibration trims the combined sensor and transmitter system to a site standard using a known temperature source. Sensor trimming is suitable for validation procedures or for applications that require calibrating the sensor and transmitter together.

To perform a sensor trim with a Rosemount 248:

Procedure

1. Connect the calibration device or sensor to the transmitter. Refer to [Figure 2-10](#) or inside of the transmitter terminal side cover for sensor wiring diagrams. If using an active calibrator, please see [Active Calibrator Mode](#).
2. Connect the communicator to the transmitter loop.
3. From the Home screen, select **1 Device Setup, 2 Diag/Service, 2 Calibration, 1 Sensor 1 Trim, 1 Sensor 1 Input Trim** to prepare to trim the sensor.
4. Set the control loop to manual and select **OK**.
5. Answer the Active Calibration question.
6. Select **1 Lower Only** or **2 Lower and Upper** at the `Select SENSOR Trim Points` prompt.
7. Adjust the calibration device to the desired trim value (must be within the selected sensor limits). If a combined sensor and transmitter system are being trimmed, expose the sensor to a known temperature and allow the temperature reading to

stabilize. Use a bath, furnace or isothermal block, measured with a site-standard thermometer, as the known temperature source.

8. Select **OK** when the temperature stabilizes. The communicator displays the output value the transmitter associates with the input value provided by the calibration device.
9. Enter the lower or upper trim point, depending on the selection in Step 6.

Output trim or scaled output trim

Perform an output trim or a scaled output trim if the digital value for the primary variable matches the plant's standards, but the transmitter's analog output does not match the reading on the output device. The output trim function calibrates the transmitter to a 4–20 mA reference scale; the scaled output trim function calibrates to a user-selectable reference scale. To determine the need for an output trim or a scaled output trim, perform a loop test as shown on [Diagnostics and service](#).

Figure 4-1: Dynamics of Smart Temperature Measurement

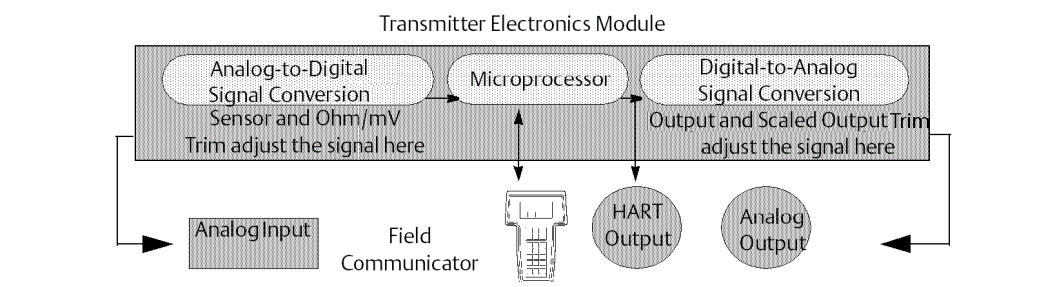

4.3 Transmitter-Sensor Natching

Use Transmitter-Sensor Matching to enhance the temperature measurement accuracy of the system and if you have a sensor with Callendar-Van Dusen constants. When ordered from Emerson, sensors with Callendar-Van Dusen constants are NIST-traceable.

The Rosemount 248 accepts Callendar-Van Dusen constants from a calibrated RTD schedule and generates a special custom curve to match that specific sensor Resistance vs. Temperature performance. [Figure 4-2](#).

Figure 4-2: Standard vs. Actual Sensor Curve

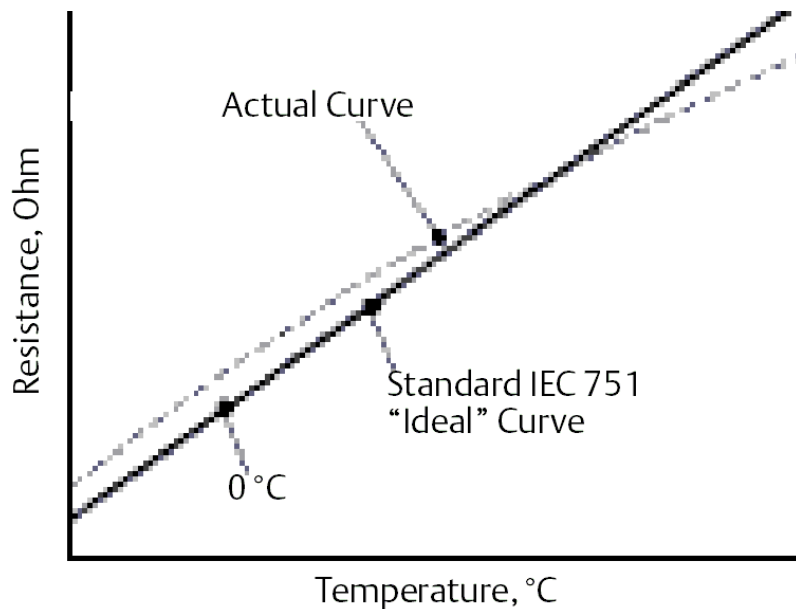

Note

The Actual Curve is identified from the Callendar-Van Dusen equation.

Matching the specific sensor curve with the transmitter significantly enhances the temperature measurement accuracy. See the comparison below in [Table 4-1](#).

Table 4-1: Standard RTD vs. RTD with Matched CVD Constants

System accuracy comparison at 150 °C using a PT 100 (α=0.00385) RTD with a span of 0 to 200 °C			
Standard RTD		Matched RTD	
Rosemount 248	±32.3 °F (±0.15 °C)	Rosemount 248	±32.3 °F (±0.15 °C)
Standard RTD	±33.89 °F (±1.05 °C)	Matched RTD	±32.32 °F (±0.18 °C)
Total System ⁽¹⁾	±33.9 °F (±1.06 °C)	Total System ⁽¹⁾	±32.4 °F (±0.23 °C)

(1) Calculated using root-summed-squared (RSS) statistical method.

$$\text{TotalSystemAccuracy} = \sqrt{(\text{TransmitterAccuracy})^2 + (\text{SensorAccuracy})^2}$$

Callendar-Van Dusen equation:

The following input variables, included with specially-ordered Rosemount temperature sensors, are required:

$$R_t = R_0 + R_0 \alpha [t - \delta(0.01t-1)(0.01t) - \beta(0.01t - 1)(0.01t)^3]$$

R0 = Resistance at Ice Point

Alpha = Sensor Specific Constant

Beta = Sensor Specific Constant

Delta = Sensor Specific Constant

To input Callendar-Van Dusen constants, perform one the following procedures:

4.3.1 Using AMS Device Manager

Procedure

1. Right click on the device and select **Configure**.
2. In the left navigation pane choose **Manual Setup** and select the **Sensor 1** or **Sensor 2** tab depending on the need.
3. Find the **Transmitter Sensor Matching (CVD)** group box and enter in the required CVD constants. Or select “Set CVD Coefficients” button to be guided through steps. You may also select “Show CVD Coefficients” button to see the current coefficients loaded into the device.
4. Select **Apply** when complete.

Note

When the transmitter-sensor matching is disabled, the transmitter reverts to either user or factory trim, whichever was used previously. Make certain the transmitter engineering units default correctly before placing the transmitter into service.

4.4 Switching HART Revision

Some systems are not capable of communicating with HART Revision 7 devices. The following procedures list how to change HART revisions between HART Revision 7 and HART Revision 5.

4.4.1 Switching HART Revision using the generic menu

If the HART configuration tool is not capable of communicating with a HART Revision 7 device, it should load a Generic Menu with limited capability. The following procedures allow for switching between HART Revision 7 and HART Revision 5 from a generic menu in any HART compliant configuration tool.

Procedure

Locate the **Message** field.

- a) To change to HART Revision 5, Enter **HART5** in the message field.
- b) To change to HART Revision 7, Enter **HART7** in the message field.

4.4.2 Using AMS Device Manager to switch HART revision

Procedure

1. Right click on the device and select **Configure**.
2. In the left navigation pane select **Manual Setup** and click on the **HART** tab.
3. Select the **Change HART Revision** button and follow the prompts.

Note

HART Revision 7 is only compatible with AMS Device Manager 10.5, and greater. AMS Device Manager version 10.5 requires a software patch to be compatible.

4.5 Hardware Maintenance

The Rosemount 248 has no moving parts and requires minimal scheduled maintenance.

4.5.1 Sensor checkout

To determine whether the sensor is at fault, replace it with another sensor or connect a test sensor locally at the transmitter to test remote sensor wiring. Do not remove the thermowell while in operation. Select any standard, off-the-shelf sensor for use with a Rosemount 248, or consult the factory for a replacement special sensor and transmitter combination.

4.6 Diagnostic messages

4.6.1 Hardware troubleshooting

If a malfunction is suspected, despite the absence of diagnostics messages on the Field Communicator display, follow the procedures described in [Table 4-2](#) to verify that transmitter hardware and process connections are in good working order. Under each of four major symptoms, specific suggestions are offered for solving the problem.

Table 4-2: Rosemount 248 Troubleshooting Chart

Symptom	Potential source	Corrective action
Transmitter Does Not Communicate with Field Communicator	Loop Wiring	<ul style="list-style-type: none"> Check for a minimum of 250 ohms resistance between the power supply and Field Communicator connection. Check for adequate voltage to the transmitter. If a Field Communicator is connected and 250 ohms resistance is in the loop, the transmitter requires a minimum of 12.0 V at the terminals to operate (over entire 3.75 to 23 mA operating range). Check for intermittent shorts, open circuits, and multiple grounds. Specify the transmitter by tag number. For certain non-standard transmitter installations, it may be necessary, because of excessive line length, to specify the transmitter tag number to initiate communications.
High Output	Sensor Input Failure or Connection	<ul style="list-style-type: none"> Connect a Field Communicator and enter the transmitter test mode to isolate a sensor failure. Check for a sensor open or short circuit. Check the process variable to see if it is out of range.

Table 4-2: Rosemount 248 Troubleshooting Chart (continued)

Symptom	Potential source	Corrective action
	Loop Wiring	<ul style="list-style-type: none"> Check for dirty or defective terminals, interconnecting pins, or receptacles.
	Power Supply	<ul style="list-style-type: none"> Check the output voltage of the power supply at the transmitter terminals. It should be 12.0 to 42.4 V dc (over entire 3.75 to 23 mA operating range).
	Electronics Module	<ul style="list-style-type: none"> Connect a Field Communicator and enter the transmitter status mode to isolate module failure. Connect a Field Communicator and check the sensor limits to ensure calibration adjustments are within the sensor range.
Erratic Output	Loop Wiring	<ul style="list-style-type: none"> Check for adequate voltage to the transmitter. It should be 12.0 to 42.4 V dc at the transmitter terminals (over entire 3.75 to 23 mA operating range). Check for intermittent shorts, open circuits, and multiple grounds. Connect a Field Communicator and enter the Loop test mode to generate signals of 4 mA, 20 mA, and user-selected values.
	Electronics Module	<ul style="list-style-type: none"> Connect a Field Communicator and enter the transmitter test mode to isolate module failure.
Low Output or No Output	Sensor Element	<ul style="list-style-type: none"> Connect a Field Communicator and enter the Transmitter test mode to isolate a sensor failure. Check the process variable to see if it is out of range.
	Loop Wiring	<ul style="list-style-type: none"> Check for adequate voltage to the transmitter. It should be 12.0 to 42.4 V dc (over entire 3.75 to 23 mA operating range). Check for shorts and multiple grounds. Check for proper polarity at the signal terminal. Check the loop impedance. Connect a Field Communicator and enter the Loop test mode. Check wire insulation to detect possible shorts to ground.
	Electronics Module	<ul style="list-style-type: none"> Connect a Field Communicator and check the sensor limits to ensure calibration adjustments are within the sensor range. Connect a Field Communicator and enter the Transmitter test mode to isolate an electronics module failure.

4.6.2 Field Communicator diagnostic messages

Table 4-3 provides a guide to Field Communicator diagnostic messages.

Variable parameters within the text of a message are indicated with the notation <variable parameter>. Reference to the name of another message is identified by the notation [another message].

Table 4-3: Field Communicator Diagnostic Messages

Message	Description
Add item for ALL device types or only for this ONE device type	Asks the user whether the hot key item being added should be added for all device types or only for the type of device that is connected.
Command Not Implemented	The connected device does not support this function.
Communication Error	Either a device sends back a response indicating that the message it received was unintelligible, or the Field Communicator cannot understand the response from the device.
Configuration memory not compatible with connected device	The configuration stored in memory is incompatible with the device to which a transfer has been requested.
Device Busy	The connected device is busy performing another task.
Device Disconnected	Device fails to respond to a command.
Device write protected	Device is in Write-Protect Mode. Data can not be written.
Device write protected. Do you still want to shut off?	Device is in Write-Protect Mode. Press YES to turn the Field Communicator off and lose the unsent data.
Display value of variable on hotkey menu?	Asks whether the value of the variable should be displayed adjacent to its label on the hotkey menu if the item being added to the hotkey menu is a variable.
Download data from configuration memory to device	Prompts user to press SEND softkey to initiate a memory to device transfer.
Exceed field width	Indicates that the field width for the current arithmetic variable exceeds the device- specified description edit format.
Exceed precision	Indicates that the precision for the current arithmetic variable exceeds the device- specified description edit format.
Ignore next 50 occurrences of status?	Asked after displaying device status. Softkey answer determines whether next 50 occurrences of device status will be ignored or displayed.
Illegal character	An invalid character for the variable type was entered.
Illegal date	The day portion of the date is invalid.
Illegal month	The month portion of the date is invalid.
Illegal year	The year portion of the date is invalid.
Incomplete exponent	The exponent of a scientific notation floating point variable is incomplete.

Table 4-3: Field Communicator Diagnostic Messages (continued)

Message	Description
Incomplete field	The value entered is not complete for the variable type.
Looking for a device	Polling for multidropped devices at addresses 1–15.
Mark as read only variable on hotkey menu?	Asks whether the user should be allowed to edit the variable from the hotkey menu if the item being added to the hotkey menu is a variable.
No device configuration in configuration memory	There is no configuration saved in memory available to re-configure off-line or transfer to a device.
No Device Found	Poll of address zero fails to find a device, or poll of all addresses fails to find a device if auto-poll is enabled.
No hotkey menu available for this device.	There is no menu named “hotkey” defined in the device description for this device.
No offline devices available.	There are no device descriptions available to be used to configure a device offline.
No simulation devices available.	There are no device descriptions available to simulate a device.
No UPLOAD_VARIABLES in ddl for this device	There is no menu named “upload_variables” defined in the device description for this device. This menu is required for offline configuration.
No Valid Items	The selected menu or edit display contains no valid items.
OFF KEY DISABLED	Appears when the user attempts to turn the Field Communicator off before sending modified data or before completing a method.
Online device disconnected with unsent data. RETRY or OK to lose data.	There is unsent data for a previously connected device. Press RETRY to send data, or press OK to disconnect and lose unsent data.
Out of memory for hotkey configuration. Delete unnecessary items.	There is no more memory available to store additional hotkey items. Unnecessary items should be deleted to make space available.
Overwrite existing configuration memory	Requests permission to overwrite existing configuration either by a device-to-memory transfer or by an offline configuration. User answers using the softkeys.
Press OK.	Press the OK softkey. This message usually appears after an error message from the application or as a result of HART communications.
Restore device value?	The edited value that was sent to a device was not properly implemented. Restoring the device value returns the variable to its original value.
Save data from device to configuration memory	Prompts user to press SAVE softkey to initiate a device-to-memory transfer.
Saving data to configuration memory.	Data is being transferred from a device to configuration memory.
Sending data to device.	Data is being transferred from configuration memory to a device.

Table 4-3: Field Communicator Diagnostic Messages (continued)

Message	Description
There are write only variables which have not been edited. Please edit them.	There are write-only variables which have not been set by the user. These variables should be set or invalid values may be sent to the device.
There is unsent data. Send it before shutting off?	Press YES to send unsent data and turn the Field Communicator off. Press NO to turn the Field Communicator off and lose the unsent data.
Too few data bytes received	Command returns fewer data bytes than expected as determined by the device description.
Transmitter Fault	Device returns a command response indicating a fault with the connected device.
Units for <variable label> has changed. Unit must be sent before editing, or invalid data will be sent.	The engineering units for this variable have been edited. Send engineering units to the device before editing this variable.
Unsent data to online device. SEND or LOSE data	There is unsent data for a previously connected device which must be sent or thrown away before connecting to another device.
Use up/down arrows to change contrast. Press DONE when done.	Gives direction to change the contrast of the Field Communicator display.
Value out of range	The user-entered value is either not within the range for the given type and size of variable or not within the min/max specified by the device.
<message> occurred reading/writing <variable label>	Either a read/write command indicates too few data bytes received, transmitter fault, invalid response code, invalid response command, invalid reply data field, or failed pre- or post-read method; or a response code of any class other than SUCCESS is returned reading a particular variable.
<variable label> has an unknown value. Unit must be sent before editing, or invalid data will be sent.	A variable related to this variable has been edited. Send related variable to the device before editing this variable.

5 Safety Instrumented Systems (SIS) requirements

5.1 SIS certification

The safety-critical output of the Rosemount™ 248 Temperature Transmitter is provided through a two-wire, 4-20 mA signal representing temperature. The Rosemount 248 Safety Certified Safety Transmitter is certified to: Low demand; Type B. The device does not provide and measures against cybersecurity threats or vulnerabilities.

- SIL 2 for random integrity at HFT=0
- SIL 3 for random integrity at HFT=1
- SIL 3 for systematic integrity

5.2 Identify safety certification

All Rosemount 248 HART® Transmitters must be indentified as safety certified before installing into SIS systems. To identify a safety certified Rosemount 248 Transmitter, make sure the device satisfies the requirements below:

1. Verify the transmitter was ordered with transmitter type option code "H" and option code "QT". This signifies that it is a 4–20mA/HART safety certified device.
 - a. For example: MODEL 248HA.....QT.....
2. Devices used in safety applications with ambient temperature below –40 °F (–40 °C) requires option code QT, and BR5 or BR6.
3. Check the Namur Software Revision located on the adhesive transmitter tag. "SW Rev _._._".
If the Device label software revision is 1.0.2 or higher, the device is safety certified.

5.3 Installation

Installation is to be performed by qualified personnel. No special installation is required in addition to the standard installation practices outlined in this document. Always ensure a proper seal by installing the electronics housing cover(s) so that metal contacts metal.

The loop should be designed so the terminal voltage does not drop below 12Vdc when the transmitter output is 24.5 mA.

Environmental limits are available on the [Rosemount 248 Temperature Transmitter Product Page](#).

5.4 Configuration

Use any HART Protocol capable configuration tool to communicate with and verify the initial configuration or any configuration changes made to the transmitter prior to operating in Safety Mode. All configuration methods outlined in Section 3.2: [Commissioning](#) are the same for the safety certified transmitter with any differences noted.

Software or hardware lock must be used in order to prevent unwanted changes to the transmitter configuration.

Note

Transmitter output is not safety-rated during the following: Configuration changes, Multidrop operation, Simulation, Active Calibrator mode, and loop tests. Alternative means should be used to ensure process safety during transmitter configuration and maintenance activities.

5.5 Operation and maintenance

5.5.1 Proof test

The following proof tests are recommended. In the event that an error is found in the safety functionality, proof test results and corrective actions taken must be documented at Emerson.com.

All proof test procedures must be carried out by qualified personnel.

5.5.2 Partial proof test 1

The partial proof test 1 consists of a power cycle plus reasonability checks of the transmitter output. Reference the FMEDA Report for percent of possible DU failures in the device.

FMEDA report can be found at Rosemount 248 Temperature Transmitter [Product Page](#).

Required tools: Field Communicator, mA meter

1. Bypass the safety PLC or take other appropriate action to avoid a false trip.
2. Send a HART command to the transmitter to go to high alarm current output and verify that the analog current reaches that value. This tests for compliance voltage problems such as low loop power supply voltage or increased wiring resistance. This also tests for other possible failures.
3. Send a HART command to the transmitter to go to the low alarm current output and verify that the analog current reaches that value. This tests for possible quiescent current related failures.
4. Use the HART communicator to view detailed device status to ensure no alarms or warnings are present in the transmitter.

5. Perform reasonability check on the sensor value(s) versus an independent estimate (i.e. from direct monitoring of BPCS value) to show current reading is good.
6. Restore the loop to full operation.
7. Remove the bypass from the safety PLC or otherwise restore to normal operation.

5.5.3 Comprehensive proof test 2

The comprehensive proof test 2 consists of performing the same steps as the partial proof test but with a two-point calibration of the temperature sensor in place of the reasonability check. Reference the FMEDA report for percent of possible DU failures in the device.

Required tools: Field Communicator, temperature calibration equipment

1. Bypass the safety PLC or take other appropriate action to avoid a false trip.
2. Perform partial proof test 1.
3. Verify the measurement for two temperature points for Sensor 1.
4. Perform reasonability check of the housing temperature.
5. Restore the loop to full operation.
6. Remove the bypass from the safety PLC or otherwise restore to normal operation.

5.5.4 Comprehensive proof test 3

The comprehensive proof test 3 includes a comprehensive proof test along with a simple sensor proof test. Reference the FMEDA report for percent of possible DU failures in the device

1. Bypass the safety PLC or take other appropriate action to avoid a false trip.
2. Perform simple proof test 1.
3. Connect calibrated sensor simulator in place of sensor 1.
4. Verify safety accuracy of two temperature points inputs to transmitter.
5. Restore sensor connections to transmitter.
6. Perform reasonability check of transmitter housing temperature.
7. Perform reasonability check on the sensor(s) values versus an independent estimate (i.e. from direct monitoring of BPCS value) to show current reading is acceptable.
8. Restore loop to full operation.
9. Remove the bypass from the safety PLC or otherwise restore to normal operation.

5.5.5 Inspection

Visual inspection	Not required.
Special tools	Not required.

Product repair The device is repairable by major component replacement.

All failures detected by the transmitter diagnostics or by the proof-test must be reported. Feedback can be submitted electronically at Emerson.com

5.6 Specifications

The Rosemount 248 Transmitter must be operated according to the functional and performance specifications provided in the Rosemount 248 [Product Data Sheet](#)

5.6.1 Failure rate data

The FMEDA report includes failure rates and independent information on generic sensor models. The report is available at Rosemount 248 Temperature Transmitter [Product Page](#).

5.6.2 Failure values

Safety accuracy (defines what FMEDA considers to be a dangerous deviation from a correct measurement):

- When the span ≥ 100 °C, the safety accuracy is $\pm 2\%$ of process variable span
- When the span < 100 °C, the safety accuracy ± 2 °C

Safety response time: 5 seconds

Self-diagnostics test interval: At least once every 60 minutes

5.6.3 Product life

50 years – based on worst case component wear-out mechanisms – not based on wear-out of process sensors.

A Reference data

A.1 Product certifications

To view current Rosemount™ 248 Temperature Transmitter Product Certifications, follow these steps:

Procedure

1. Go to [Emerson.com/Rosemount/Rosemount-248](https://emerson.com/Rosemount/Rosemount-248).
2. Scroll as needed to the green menu bar and click **Documents & Drawings**.
3. Click **Manuals & Guides**.
4. Select the appropriate Quick Start Guide.

A.2 Ordering Information, Specifications, and Drawings

To view current Rosemount 248 Ordering information, Specifications, and Drawings, follow these steps:

Procedure

1. Go to [Emerson.com/Rosemount/Rosemount-248](https://emerson.com/Rosemount/Rosemount-248).
2. Scroll as needed to the green menu bar and click **Documents & Drawings**.
3. For installation drawings, click **Drawings & Schematics** and select the appropriate document.
4. For ordering information, specifications, and dimensional drawings, click **Data Sheets & Bulletins**.
5. Select the appropriate Product Data Sheet.

Global Headquarters

Emerson Automation Solutions
6021 Innovation Blvd.
Shakopee, MN 55379, USA

📞 +1 800 999 9307 or +1 952 906 8888
☎️ +1 952 204 8889
✉️ RFQ.RMD-RCC@Emerson.com

North America Regional Office

Emerson Automation Solutions
8200 Market Blvd.
Chanhassen, MN 55317, USA

📞 +1 800 999 9307 or +1 952 906 8888
☎️ +1 952 204 8889
✉️ RMT-NA.RCCRFQ@Emerson.com

Latin America Regional Office

Emerson Automation Solutions
1300 Concord Terrace, Suite 400
Sunrise, FL 33323, USA

📞 +1 954 846 5030
☎️ +1 954 846 5121
✉️ RFQ.RMD-RCC@Emerson.com

Europe Regional Office

Emerson Automation Solutions Europe
GmbH
Neuhofstrasse 19a P.O. Box 1046
CH 6340 Baar
Switzerland

📞 +41 (0) 41 768 6111
☎️ +41 (0) 41 768 6300
✉️ RFQ.RMD-RCC@Emerson.com

Asia Pacific Regional Office

Emerson Automation Solutions
1 Pandan Crescent
Singapore 128461

📞 +65 6777 8211
☎️ +65 6777 0947
✉️ Enquiries@AP.Emerson.com

Middle East and Africa Regional Office

Emerson Automation Solutions
Emerson FZE P.O. Box 17033
Jebel Ali Free Zone - South 2
Dubai, United Arab Emirates

📞 +971 4 8118100
☎️ +971 4 8865465
✉️ RFQ.RMTMEA@Emerson.com

 [Linkedin.com/company/Emerson-Automation-Solutions](https://www.linkedin.com/company/Emerson-Automation-Solutions)

 [Twitter.com/Rosemount_News](https://twitter.com/Rosemount_News)

 [Facebook.com/Rosemount](https://www.facebook.com/Rosemount)

 [Youtube.com/user/RosemountMeasurement](https://www.youtube.com/user/RosemountMeasurement)

©2019 Emerson. All rights reserved.

Emerson Terms and Conditions of Sale are available upon request. The Emerson logo is a trademark and service mark of Emerson Electric Co. Rosemount is a mark of one of the Emerson family of companies. All other marks are the property of their respective owners.