

# Rosemount™ 3051S Series Pressure Transmitter and Rosemount 3051SF Series Flow Meter

with HART® Protocol

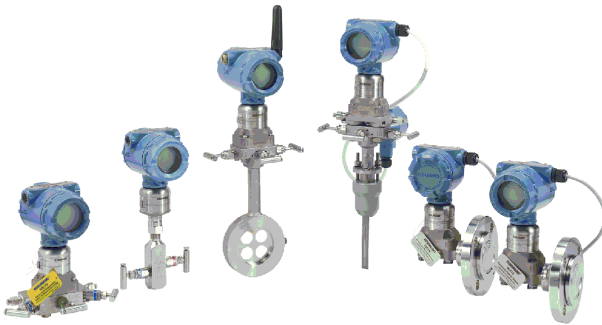

HART WirelessHART IEC CE



Scan here for product documentation and drawings.

## Safety messages

### NOTICE

This guide provides basic guidelines for Rosemount™ 3051S Series Pressure Transmitters. It also provides the basic electronic guidelines for the Rosemount 3051SFA [Reference Manual](#), Rosemount 3051SFC [Reference Manual](#), and Rosemount 3051SFP [Reference Manual](#). It does not provide instructions for diagnostics, maintenance, service, or troubleshooting. Refer to the Rosemount 3051S HART [Reference Manual](#) for more instruction. This document is also available electronically on [Emerson.com/Rosemount](http://Emerson.com/Rosemount).

### ⚠ WARNING

Explosions could result in death or serious injury.

- Do not remove the transmitter cover in explosive atmospheres when the circuit is live.
- Both transmitter covers must be fully engaged to meet explosion-proof requirements.
- Ensure device is installed in accordance with intrinsically safe or non-incendive field practices.

Process leaks could result in death or serious injury.

- To avoid process leaks, only use the O-ring designed to seal with the corresponding flange adapter.

Electrical shock could cause death or serious injury.

- Avoid contact with the leads and terminals. High voltage that may be present on leads can cause electrical shock.

## Contents

Mount the transmitter.....	3
Consider housing rotation.....	9
Set switches and jumpers.....	10
Connect wiring and power up.....	12
Verify configuration.....	20
Trim the transmitter.....	24
Safety instrumented systems installation.....	26
Rosemount 3051S/3051SFx/3051S-ERS Product Certifications.....	27
Rosemount 3051S Declaration of Conformity.....	43
China RoHS.....	47

# 1 Mount the transmitter

## 1.1 Liquid flow applications

### Procedure

1. Place taps to the side of the line.
2. Mount beside or below the taps.
3. Mount the transmitter so that the drain/vent valves are oriented upward.

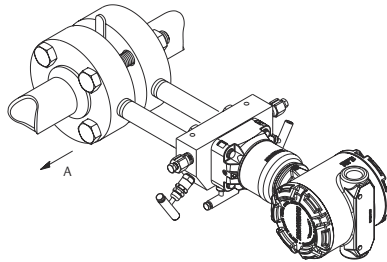

A. Direction of flow

## 1.2 Gas flow applications

### Procedure

1. Place taps in the top or side of the line.
2. Mount beside or above the taps.

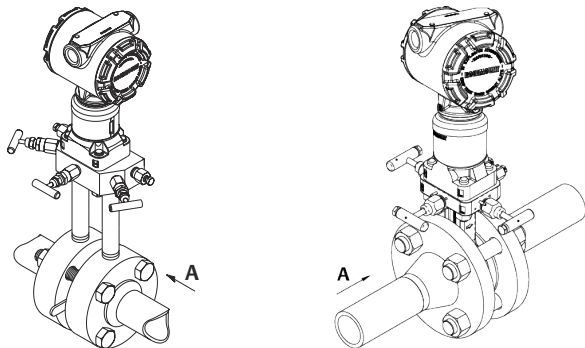

A. Direction of flow

## 1.3 Steam flow applications

### Procedure

1. Place taps to the side of the line.
2. Mount beside or below the taps.
3. Fill impulse lines with water.

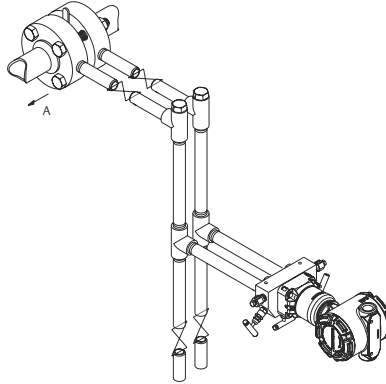

A. Direction of flow

## 1.4 Using a mounting bracket

If the transmitter requires the use of a mounting bracket, use the images below for instructions on how to properly mount the transmitter using the Emerson™ provided mounting brackets. Use only bolts provided with the transmitter or sold as Emerson spare parts.

## 1.5 Bolting considerations

If the transmitter installation requires assembly of a process flange, manifold, or flange adapters, follow these assembly guidelines to ensure a tight seal for optimal performance characteristics of the transmitter. Only use bolts supplied with the transmitter or sold by Emerson™ as spare parts. [Figure 1-1](#) illustrates common transmitter assemblies with the bolt length required for proper transmitter assembly.

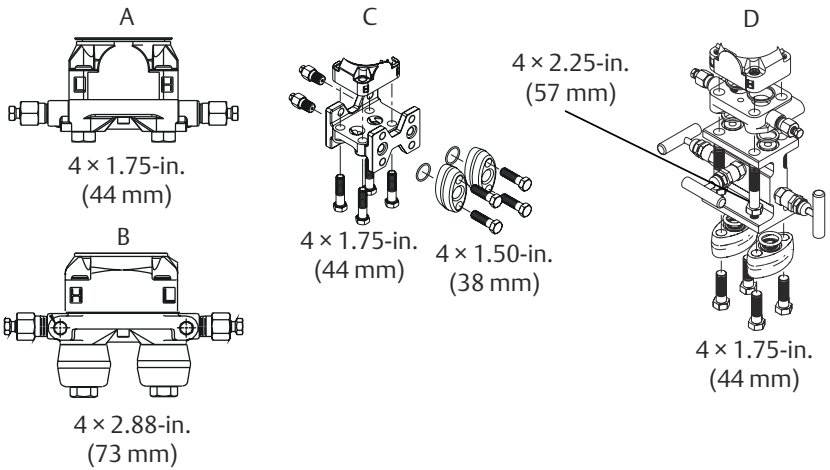
**Figure 1-1: Common Transmitter Assemblies**

- A. Transmitter with coplanar flange
- B. Transmitter with coplanar flange and optional flange adapters
- C. Transmitter with traditional flange and optional flange adapters
- D. Transmitter with coplanar flange and optional Rosemount Conventional Manifold and flange adapters

**Note**

For all other manifolds, contact Customer Central technical support.

Bolts are typically carbon steel or stainless steel. Confirm the material by viewing the markings on the head of the bolt and referencing [Table 1-1](#). If bolt material is not shown in [Table 1-1](#), contact the local Emerson representative for more information.

Use the following bolt installation procedure:

**Procedure**

1. Carbon steel bolts do not require lubrication and the stainless steel bolts are coated with a lubricant to ease installation. However, no additional lubricant should be applied when installing either type of bolt.
2. Finger-tighten the bolts.
3. Torque the bolts to the initial torque value using a crossing pattern. See [Table 1-1](#) for initial torque value.
4. Torque the bolts to the final torque value using the same crossing pattern. See [Table 1-1](#) for final torque value.

- Verify the flange bolts are protruding through the sensor module before applying pressure (see [Figure 1-2](#)).

**Example**

**Table 1-1: Torque Values for the Flange and Flange Adapter Bolts**

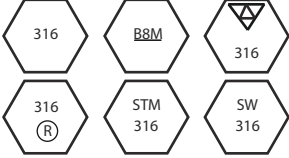
Bolt material	Head markings	Initial torque	Final torque
Carbon Steel (CS)		300 in-lb	650 in-lb
Stainless Steel (SST)		150 in-lb	300 in-lb

**Figure 1-2: Proper Bolt Installation**

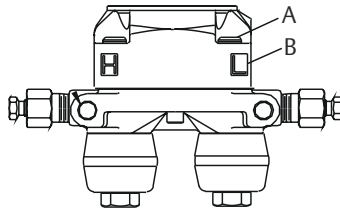

- A. Bolt
- B. Sensor module

## 1.6 O-rings with flange adapters

### ⚠ WARNING

Failure to install proper flange adapter O-rings may cause process leaks, which can result in death or serious injury. Only use the O-ring that is designed for its specific flange adapter.

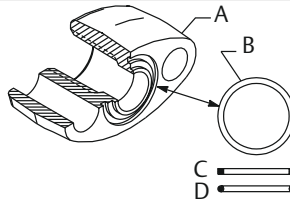

- A. Flange adapter
- B. O-ring
- C. PTFE-based profile (square)
- D. Elastomer profile (round)

Whenever the flange or adapters are removed, visually inspect the O-rings. Replace them if there are any signs of damage, such as nicks or cuts. If the O-rings are replaced, re-torque the flange bolts and alignment screws after installation to compensate for seating of the O-rings.

## 1.7 In-line gage transmitter orientation

The low side pressure port (atmospheric reference) on the in-line gage transmitter is located under the sensor module neck label. (See [Figure 1-3](#))

Keep the vent path free of any obstruction, including but not limited to paint, dust, and lubrication by mounting the transmitter so that any contaminants can drain away.

**Figure 1-3: In-line Gage Transmitter**

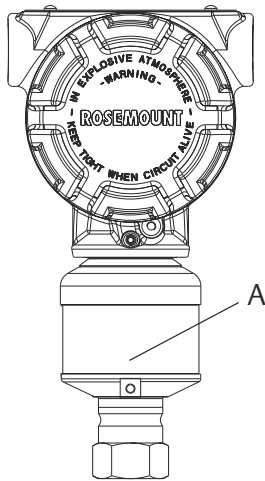

A. Low side pressure port (under neck label)



## 2 Consider housing rotation

To improve field access to wiring or to better view the optional LCD display:

### Procedure

1. Loosen the housing rotation set screw.
2. Turn the housing up to 180° left or right of its original (as shipped) position.
3. Re-tighten the housing rotation set screw.

---

**Figure 2-1: Transmitter Housing Set Screw**

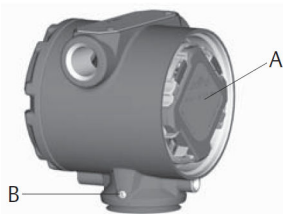

A. LCD display

B. Housing rotation set screw (3/32-in.)

---

### **⚠ CAUTION**

Do not rotate the housing more than 180° without first performing a disassembly procedure. Over-rotation may sever the electrical connection between the sensor module and the electronics.

---

### 3 Set switches and jumpers

If alarm and security adjustment option is not installed, the transmitter will operate normally with the default alarm condition alarm “high” and the security “off”.

#### Procedure

1. Do not remove the transmitter covers in explosive atmospheres when the circuit is live. If the transmitters is live, set the loop to manual and remove power.
2. Remove the electronics compartment cover. On the Plantweb housing the cover is opposite the field terminals side, or on the junction box housing remove the terminal block cover. Do not remove the housing cover in explosive environments.
3. On the Plantweb housing, slide the security and alarm switches into the preferred position by using a small screwdriver (An LCD display or an adjustment module must be in place to activate the switches). On the junction box housing pull the pins out and rotate 90° into desired position to set the security and alarm.
4. Reinstall the housing cover so metal contacts metal to meet explosion-proof requirements.

**Figure 3-1: Transmitter Switch and Jumper Configuration (Plantweb)**

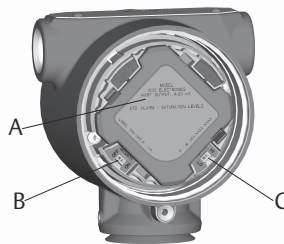

- A. Meter/adjustment module
- B. Security
- C. Alarm

---

**Figure 3-2: Transmitter Switch and Jumper Configuration (Junction Box)**

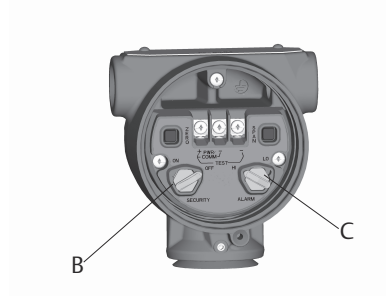

- A. Meter/adjustment module
  - B. Security
  - C. Alarm
-

## 4 Connect wiring and power up

### Procedure

1. Remove and discard orange conduit plugs.
2. Remove the housing cover labeled “Field Terminals.”

---

#### Note

Do not connect the power across the test terminals. Power could damage the test diode in the test connection. Twisted pairs yield best results. Use 24–14 AWG wire and do not exceed 5,000 ft. (1,500 m). For single compartment housing (Junction Box housing), shielded signal wiring should be used in high EMI/RFI environments.

---

3. Connect the positive lead to the “+” terminal, and the negative lead to the “-” terminal.
4.  **CAUTION**

When the enclosed threaded plug is utilized in the conduit opening, it must be installed with a minimum thread engagement in order to comply with explosion-proof requirements. For straight threads, a minimum of seven threads must be engaged. For tapered threads, a minimum of five threads must be engaged.

---

Plug and seal the unused conduit connection with the provided conduit plug.

5. If applicable, install wiring with a drip loop. Arrange the drip loop so the bottom is lower than the conduit connections and the transmitter housing.
6. Reinstall the housing cover and tighten so the cover is fully seated with metal to metal contact between the housing and cover in order to meet explosion proof requirements.

The figures below show the wiring connections necessary to power a transmitter and enable communications with a hand-held Field Communicator.

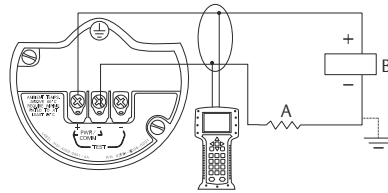
**Figure 4-1: Transmitter Wiring (Plantweb Housing)**

- A.  $RL \geq 250 \Omega$   
 B. Power supply

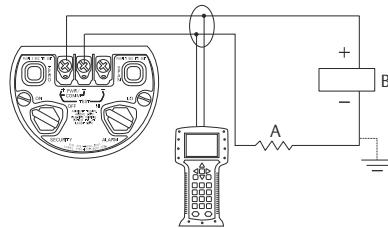
**Figure 4-2: Transmitter Wiring (Junction Box Housing)**

- A.  $RL \geq 250 \Omega$   
 B. Power supply

**Note**

Installation of the transient protection terminal block does not provide protection unless the Rosemount 3051S case is properly grounded.

## 4.1 Ground signal wiring

Do not run signal wiring in conduit or open trays with power wiring, or near heavy electrical equipment. Grounding terminations are provided on the sensor module and inside the terminal compartment. These grounds are used when transient protection terminal blocks are installed or to fulfill local regulations.

**Procedure**

1. Remove the Field Terminals housing cover.
2. Connect the wiring pair and ground as indicated in [Figure 4-3](#).  
The cable shield should:
  - Be trimmed close and insulated from touching the transmitter housing

- Continuously connect to the termination point
- Be connected to a good earth ground at the power supply end

**Figure 4-3: Wiring**

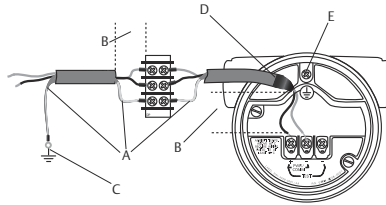

- Insulate shield*
- Minimize distance*
- Connect shield back to the power supply ground*
- Trim shield and insulate*
- Safety ground*

3. Replace the housing cover. It is recommended the cover be tightened until there is no gap between the cover and the housing.
4. Plug and seal the unused conduit connection with the provided conduit plug.

## 4.2 Remote display wiring and power up (if applicable)

The remote mount display and Interface system consists of a local transmitter and a remote mount LCD display assembly. The local Rosemount 3051S assembly includes a Junction Box housing with a three-position terminal block integrally mounted to a sensor module. The remote mount LCD display assembly consists of a dual compartment Plantweb housing with a seven position terminal block. See [Figure 4-4](#) for complete wiring instructions. The following is a list of necessary information specific to the remote mount display system:

- Each terminal block is unique for the remote display system.
- A 316 SST housing adaptor is permanently secured to the remote mount LCD display Plantweb housing, providing an external ground and a means for field mounting with the provided mounting bracket.
- A cable is required for wiring between the transmitter and remote mount LCD display. The cable length is limited to 100 ft.
- 50 ft. (option M8) or 100 ft. (option M9) cable is provided for wiring between the transmitter and remote mount LCD display. Option M7 does not include cable; see recommended specifications below.

### Cable type

Recommend Madison AWM Style 2549 cable. Other comparable cable may be used as long as it has independent dual twisted shielded pair wires with an outer shield. The power wires must be 22 AWG minimum and the CAN communication wires must be 24 AWG minimum.

### Cable length

The cable length is up to 100 ft .depending upon cable capacitance.

### Cable capacitance

The capacitance from the CAN communications line to the CAN return line as wired must be less than 5,000 picofarads total. This allows up to 50 picofarads per foot for a 100 foot cable.

### Intrinsic safety consideration

The transmitter assembly with remote display has been approved with Madison AWM Style 2549 cable. Alternate cable may be used as long as the transmitter with remote display and cable is configured according to the installation control drawing or certificate. Refer to appropriate approval certificate or control drawing in Appendix B of the Rosemount 3051S [Reference Manual](#) for remote cable IS requirements.

## **⚠ CAUTION**

Do not apply power to the remote communications terminal. Follow wiring instructions carefully to prevent damage to system components.

---

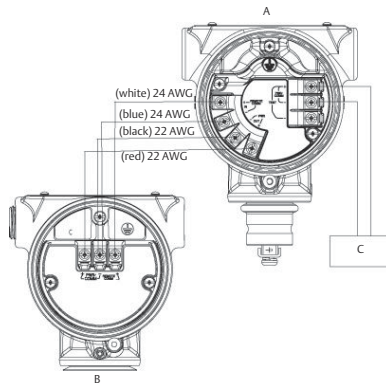
**Figure 4-4: Remote Mount Display Wiring Diagram**

- A. Remote mount display
- B. Junction box housing
- C. 4–20 mA

**Note**

Wire colors provided are per Madison AWM Style 2549 cable. Wire color may vary depending on cable selected.

Madison AWM Style 2549 cable includes a ground shield. This shield must be connected to earth ground at either the sensor module or the remote display, but not both.

### 4.3 Quick connect wiring (if applicable)

As standard, the Rosemount 3051S Quick Connect arrives properly assembled to the sensor module and is ready for installation. Cordsets and field wireable connectors (in shaded area) are sold separately.

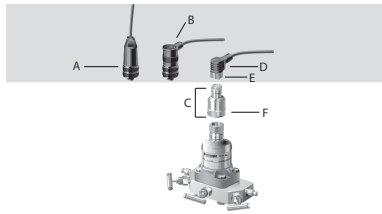

---

**Figure 4-5: Rosemount 3051S Quick Connect Exploded View**

- A. *Straight field wireable connector (part number 03151-9063-0001), supplied by customer*
- B. *Right angle field wireable connector (part number 03151-9063-0002), supplied by customer*
- C. *Quick Connect housing*
- D. *Cordset, supplied by vendor*
- E. *Coupling nut*
- F. *Quick Connect coupling nut*

---

**Important**

If Quick Connect is ordered as a Rosemount 300S spare housing or is removed from the sensor module, follow the instructions below for proper assembly prior to field wiring.

---

**Procedure**

1. Place the Quick Connect onto the sensor module. To ensure proper pin alignment, remove coupling nut prior to installing quick connect onto the sensor module.
2. Place coupling nut over quick connect and wrench tighten to a maximum of 300 in-lb (34 N-m).
3. Tighten the set screw up to 30 in-lb using a 3/32-in. hex wrench.
4. Install cordset/field wireable connectors onto the Quick Connect. Do not over tighten.

---

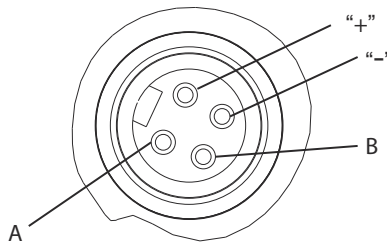
**Figure 4-6: Quick Connect Housing Pin-Out**

- A. Ground  
B. No connection
- 

**Note**

For other wiring details, refer to pin-out drawing and the cordset manufacturer's installation instructions.

---

#### 4.4 Conduit electrical connector wiring (option GE or GM)

For Rosemount 3051S with conduit electrical connectors GE or GM, refer to the cordset manufacturer's installation instructions for wiring details. For FM Intrinsically Safe, non-incendive or FM FISCO Intrinsically Safe hazardous locations, install in accordance with Rosemount drawing 03151-1009. See Appendix B of the Rosemount 3051S [Reference Manual](#).

#### 4.5 Power supply

The DC power supply should provide power with less than two percent ripple. The total resistance load is the sum of the resistance of the signal leads and the load resistance of the controller, indicator, and related pieces.

---

**Note**

The resistance of intrinsic safety barriers, if used, must be included.

---

**Figure 4-7: Load Limitation**

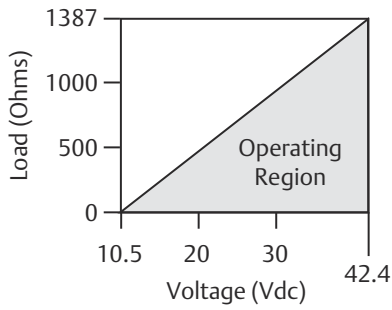

Maximum loop resistance =  $43.5 \times (\text{power supply voltage} - 10.5)$

The Field Communicator requires a minimum loop resistance of  $250\Omega$  for communication.

## 5 Verify configuration

Use any HART-compliant master to communicate with and verify configuration of the Rosemount 3051S.

### Field Communicator user interface

Fast Key sequences vary with the device driver revision. Reference [Table 5-1](#) for DD Rev. 8 or older. Reference [Table 5-2](#) for DD Rev. 9 or newer.

**Figure 5-1: Traditional Interface - Device Revision 6 or 7 and DD Revision 7**

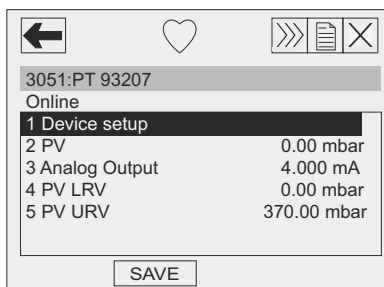

**Figure 5-2: Device Dashboard - Device Revision 7 and DD Revision 9**

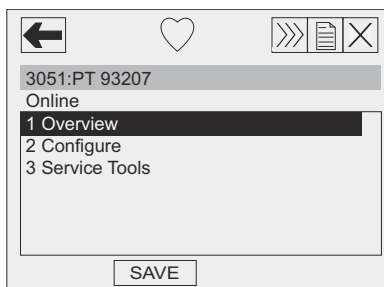

A check (✓) indicates the basic configuration parameters. At a minimum, these parameters should be verified as part of the configuration and startup procedure.

**Table 5-1: Fast Key Sequences-Traditional Interface (Device Revision 6 or 7 and DD Revision 7)**

	Function	Fast Key sequence
	Alarm Level Configuration	1, 4, 2, 7, 7

**Table 5-1: Fast Key Sequences-Traditional Interface (Device Revision 6 or 7 and DD Revision 7) (continued)**

	Function	Fast Key sequence
	Alarm and Saturation Levels	1, 4, 2, 7
	Analog Output Alarm Direction	1, 4, 2, 7, 6
	Analog Output Trim	1, 2, 3, 2
	Burst Mode On/Off	1, 4, 3, 3, 3
	Burst Options	1, 4, 3, 3, 4
✓	Damping	1, 3, 6
	Date	1, 3, 4, 1
	Descriptor	1, 3, 4, 2
	Digital To Analog Trim (4–20 mA Output)	1, 2, 3, 2, 1
	Field Device Information	1, 4, 4, 1
	LCD Display Configuration	1, 3, 7
	Loop Test	1, 2, 2
	Lower Sensor Trim	1, 2, 3, 3, 2
	Message	1, 3, 4, 3
	Number of Requested Preambles	1, 4, 3, 3, 2
	Pressure Alert Configuration	1, 4, 3, 5, 3
	Poll Address	1, 4, 3, 3, 1
	Poll a Multidropped Transmitter	Left Arrow, 3, 1, 1
	Remapping	1, 4, 3, 6
	Rerange- Keypad Input	1, 2, 3, 1, 1
	Saturation Level Configuration	1, 4, 2, 7, 8
	Scaled D/A Trim (4–20 mA Output)	1, 2, 3, 2, 2
	Scaled Variable Configuration	1, 4, 3, 4, 7
	Self Test (Transmitter)	1, 2, 1, 1

**Table 5-1: Fast Key Sequences-Traditional Interface (Device Revision 6 or 7 and DD Revision 7) (continued)**

	Function	Fast Key sequence
	Sensor Information	1, 4, 4, 2
	Sensor Temperature	1, 1, 4
	Sensor Trim	1, 2, 3, 3
	Sensor Trim Points	1, 2, 3, 3, 5
	Status	1, 2, 1, 2
✓	Tag	1, 3, 1
	Temperature Alert Configuration	1, 4, 3, 5, 4
✓	Transfer Function (Setting Output Type)	1, 3, 5
	Transmitter Security (Write Protect)	1, 3, 4, 5
✓	Units (Process Variable)	1, 3, 2
	Upper Sensor Trim	1, 2, 3, 3, 3
	Zero Trim	1, 2, 3, 3, 1

**Table 5-2: Fast Key Sequences-Device Dashboard (Device Revision 7 and DD Revision 9)**

	Function	Fast Key sequence
	Alarm and Saturation Levels	2, 2, 1, 7
	Burst Mode Control	2, 2, 4, 2
	Burst Option	2, 2, 4, 3
	Custom Display Configuration	2, 1, 3
✓	Damping	2, 2, 1, 5
	Date	2, 2, 5, 4
	Descriptor	2, 2, 5, 5
	Digital to Analog Trim (4–20 mA Output)	3, 4, 2
	Disable Zero & Span Adjustment	2, 2, 7, 2

**Table 5-2: Fast Key Sequences-Device Dashboard (Device Revision 7 and DD Revision 9) (continued)**

	Function	Fast Key sequence
	Rerange with Keypad	2, 2, 1, 3, 1
	Loop Test	3, 5, 1
	Lower Sensor Trim	3, 4, 1, 2
	Message	2, 2, 5, 6
	Range Values	2, 2, 1, 3
	Scaled D/A Trim (4–20 mA Output)	3, 4, 2
	Sensor Temperature/ Trend (3051S)	3, 3, 3
✓	Tag	2, 2, 5, 1
✓	Transfer Function	2, 2, 1, 4
	Transmitter Security (Write Protect)	2, 2, 7, 1
✓	Units	2, 2, 1, 2
	Upper Sensor Trim	3, 4, 1, 1
	Zero Trim	3, 4, 1, 3

## 6 Trim the transmitter

Transmitters are shipped fully calibrated per request or by the factory default of full scale (lower range value = zero, upper range value = upper range limit).

### 6.1 Zero trim

#### Prerequisites

Choose your trim procedure

1. Analog zero trim - sets the analog output to 4 mA.
  - a. Also referred to as a "rerange", it sets the lower value range (LRV) equal to the measured pressure.
  - b. The display and digital HART output remains unchanged.
2. Digital zero trim - recalibrates the sensor zero.
  - a. The LRV is unaffected. The pressure value will be zero (on display and HART output). 4 mA point may not be at zero.
  - b. The transmitter must be within 3 percent of URL from factory calibrated zero pressure in order to calibrate the zero function.

#### 6.1.1 Use the Field Communicator

##### Procedure

1. Equalize or vent the transmitter and connect Field Communicator.
2. At the menu, input the Fast Key sequence (refer to [Field Communicator user interface](#)).
3. Follow the commands to perform a zero trim.

#### 6.1.2 Use the transmitter zero adjustment button

##### Procedure

To perform an analog zero trim using the transmitter buttons push and hold the zero adjustment button for at least two seconds but no longer than 10 seconds.



---

**Figure 6-1: Transmitter Adjustment Buttons (Plantweb Housing)**

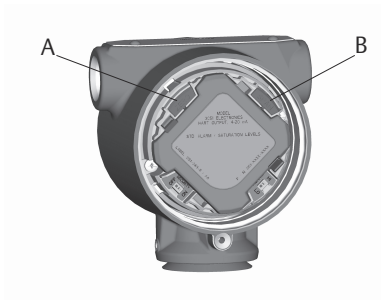

- A. Zero
- B. Span

---

**Figure 6-2: Transmitter Adjustment Buttons (Junction Box Housing)**

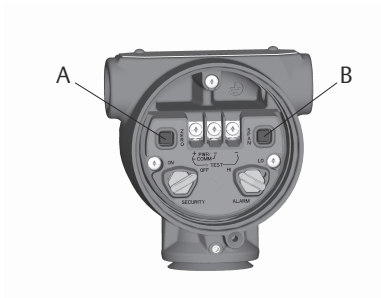

- A. Zero
- B. Span

## 7 Safety instrumented systems installation

For safety certified installations, refer to the Rosemount 3051S [Reference Manual](#) for installation procedure and system requirements.

## 8 Rosemount 3051S/3051SFx/3051S-ERS Product Certifications

Rev 2.5

### European Directive Information

A copy of the EU Declaration of Conformity can be found at the end of the Quick Start Guide. The most recent revision of the EU Declaration of Conformity can be found at [Emerson.com/Rosemount](http://Emerson.com/Rosemount).

### Ordinary Location Certification

As standard, the transmitter has been examined and tested to determine that the design meets the basic electrical, mechanical, and fire protection requirements by a nationally recognized test laboratory (NRTL) as accredited by the Federal Occupational Safety and Health Administration (OSHA).

### Installing Equipment in North America

The US National Electrical Code® (NEC) and the Canadian Electrical Code (CEC) permit the use of Division marked equipment in Zones and Zone marked equipment in Divisions. The markings must be suitable for the area classification, gas, and temperature class. This information is clearly defined in the respective codes.

## 8.1 USA

### 8.1.1 E5 US Explosionproof (XP) and Dust-Ignitionproof (DIP)

**Certificate** FM16US0090

**Standards** FM Class 3600 - 2011, FM Class 3615 - 2006, FM Class 3616 - 2011, FM Class 3810 - 2005, ANSI/NEMA 250 - 2003

**Markings** XP CL I, DIV 1, GP B, C, D; DIP CL II, DIV 1, GP E, F, G; CL III; T5(-50 °C ≤ T<sub>a</sub> ≤ +85 °C); Factory Sealed; Type 4X

### 8.1.2 I5 US Intrinsic Safety (IS) and Nonincendive (NI)

**Certificate** FM16US0089X

**Standards** FM Class 3600 - 2011, FM Class 3610 - 2010, FM Class 3611 - 2004, FM Class 3810 - 2005, NEMA® 250 - 2003

**Markings** IS CL I, DIV 1, GP A, B, C, D; CL II, DIV 1, GP E, F, G; Class III; Class 1, Zone 0 AEx ia IIC T4; NI CL 1, DIV 2, GP A, B, C, D; T4(-50 °C ≤ T<sub>a</sub> ≤ +70 °C) [HART]; T4(-50 °C ≤ T<sub>a</sub> ≤ +60 °C) [Fieldbus]; when connected per Rosemount drawing 03151-1006; Type 4X

**Special Condition for Safe Use:**

1. The Model 3051S/3051S-ERS Pressure Transmitter contains aluminum and is considered to constitute a potential risk of ignition by impact or friction. Care must be taken into account during installation and use to prevent impact and friction.

**Note**

Transmitters marked with NI CL 1, DIV 2 can be installed in Division 2 locations using general Division 2 wiring methods or Nonincendive Field Wiring (NIFW). See Drawing 03151-1006.

## 8.1.3 IE US FISCO Intrinsically Safe

**Certificate** FM16US0089X

**Standards** FM Class 3600 - 2011, FM Class 3610 - 2010, FM Class 3611 - 2004, FM Class 3810 - 2005, NEMA 250 - 2003

**Markings** IS CL I, DIV 1, GP A, B, C, D; T4(-50 °C ≤ T<sub>a</sub> ≤ +60 °C); when connected per Rosemount drawing 03151-1006; Type 4X

**Special Condition for Safe Use:**

1. The Rosemount 3051S/3051S-ERS Pressure Transmitter contains aluminum and is considered to constitute a potential risk of ignition by impact or friction. Care must be taken into account during installation and use to prevent impact and friction.

## 8.2 Canada

## 8.2.1 E6 Canada Explosionproof, Dust-Ignitionproof, and Division 2

**Certificate** 1143113

**Standards** CAN/CSA C22.2 No. 0-10, CSA Std C22.2 No. 25-1966, CSA Std C22.2 No. 30-M1986, CAN/CSA C22.2 No. 94-M91, CSA Std C22.2 No. 142-M1987, CSA Std C22.2 No. 213-M1987, ANSI/ISA 12.27.01-2003, CSA Std C22.2 No. 60529:05

**Markings** Explosionproof Class I, Division 1, Groups B, C, D; Dust-Ignitionproof Class II, Division 1, Groups E, F, G; Class III; suitable for Class I, Zone 1, Group IIB+H2, T5; suitable for Class I, Division 2, Groups A, B, C, D; suitable for Class I, Zone 2, Group IIC, T5; when connected per Rosemount drawing 03151-1013; Type 4X

## 8.2.2 I6 Canada Intrinsically Safe

**Certificate** 1143113

**Standards** CAN/CSA C22.2 No. 0-10, CSA Std C22.2 No. 25-1966, CSA Std C22.2 No. 30-M1986, CAN/CSA C22.2 No. 94-M91, CSA Std C22.2 No. 142-M1987, CSA Std C22.2 No. 157-92, ANSI/ISA 12.27.01-2003, CSA Std C22.2 No. 60529:05

**Markings** Intrinsically Safe Class I, Division 1; Groups A, B, C, D; suitable for Class 1, Zone 0, IIC, T3C; when connected per Rosemount drawing 03151-1016 [3051S] 03151-1313 [ERS]; Type 4X

### 8.2.3 IF Canada FISCO

**Certificate** 1143113

**Standards** CAN/CSA C22.2 No. 0-10, CSA Std C22.2 No. 30-M1986, CAN/CSA C22.2 No. 94-M91, CSA Std C22.2 No. 142-M1987, CSA Std C22.2 No. 157-92, ANSI/ISA 12.27.01-2003, CSA Std C22.2 No. 60529:05

**Markings** FISCO Intrinsically Safe Class I, Division 1; Groups A, B, C, D; suitable for Class 1, Zone 0, IIC, T3C; when connected per Rosemount drawing 03151-1016 [3051S] 03151-1313 [ERS]; Type 4X

## 8.3 Europe

### 8.3.1 E1 ATEX Flameproof

**Certificate** KEMA 00ATEX2143X

**Standards** EN 60079-0:2012+A11:2013, EN 60079-1:2014, EN 60079-26:2015

**Markings**  II 1/2 G Ex db IIC T6...T4 Ga/Gb, T6(-60 °C ≤ T<sub>a</sub> ≤ +70 °C), T5/T4(-60 °C ≤ T<sub>a</sub> ≤ +80 °C)

**Table 8-1: Process Temperature**

Temperature class	Process temperature
T6	-60 °C to +70 °C
T5	-60 °C to +80 °C
T4	-60 °C to +120 °C

### Special Conditions for Safe Use (X):

1. This device contains a thin wall diaphragm less than 1 mm thickness that forms a boundary between Category 1 (process connection) and Category 2 (all other parts of the equipment). The model code and datasheet are to be consulted for details of the diaphragm material. Installation, maintenance and use shall take into account the

environmental conditions to which the diaphragm will be subjected. The manufacturer's instructions for installation and maintenance shall be followed in detail to assure safety during its expected lifetime.

2. Flameproof joints are not intended for repair.
3. Non-standard paint options may cause risk from electrostatic discharge. Avoid installations that could cause electrostatic build-up on painted surfaces, and only clean the painted surfaces with a damp cloth. If paint is ordered through a special option code, contact the manufacturer for more information.
4. Appropriate cable, glands and plugs need to be suitable for a temperature of 5 °C greater than maximum specified temperature for location where installed.

### 8.3.2 I1 ATEX Intrinsic Safety

**Certificate** BAS01ATEX1303X

**Standards** EN 60079-0: 2012+A11:2013, EN 60079-11: 2012

**Markings**  II 1 G Ex ia IIC T4 Ga, T4(-60 °C ≤ T<sub>a</sub> ≤ +70 °C)

**Table 8-2: Input Parameters**

	U <sub>i</sub>	I <sub>i</sub>	P <sub>i</sub>	C <sub>i</sub>	L <sub>i</sub>
SuperModule	30 V	300 mA	1.0 W	30 nF	0
3051S...A; 3051SF...A; 3051SAL...C	30 V	300 mA	1.0 W	12 nF	0
3051S...F; 3051SF...F	30 V	300 mA	1.3 W	0	0
3051S ...A...M7, M8, or M9; 3051SF ...A... M7, M8, or M9; 3051SAL...C... M7, M8, or M9	30 V	300 mA	1.0 W	12 nF	60 μH
3051SAL or 3051SAM	30 V	300 mA	1.0 W	12 nF	33 μH
3051SAL...M7, M8, or M9 3051SAM...M7, M8, or M9	30 V	300 mA	1.0 W	12 nF	93 μH
RTD Option for 3051SF	5 V	500 mA	0.63 W	N/A	N/A

#### Special Conditions for Safe Use (X):

1. The Model 3051S Transmitters fitted with transient protection are not capable of withstanding the 500 V test as defined in Clause

- 6.3.13 f EN 60079-11:2012. This must be taken into account during installation.
2. The terminal pins of the Model 3051S SuperModule must be provided with a degree of protection of at least IP20 in accordance with IEC/EN 60529.
  3. The Model 3051S enclosure may be made of aluminum alloy and given a protective polyurethane paint finish; however, care should be taken to protect it from impact or abrasion if located in a zone 0 area.

### 8.3.3 IA ATEX FISCO

- Certificate** BAS01ATEX1303X
- Standards** EN 60079-0: 2012+A11:2013, EN 60079-11: 2012
- Markings**  II 1 G Ex ia IIC T4 Ga, T4(-60 °C ≤ T<sub>a</sub> ≤ +70 °C)

**Table 8-3: Input Parameters**

Parameter	FISCO
Voltage U <sub>i</sub>	17.5 V
Current I <sub>i</sub>	380 mA
Power P <sub>i</sub>	5.32 W
Capacitance C <sub>i</sub>	0
Inductance L <sub>i</sub>	0

#### Special Conditions for Safe Use (X):

1. The Model 3051S Transmitters fitted with transient protection are not capable of withstanding the 500 V test as defined in Clause 6.3.13 of EN 60079-11:2012. This must be taken into account during installation.
2. The terminal pins of the Model 3051S SuperModule must be provided with a degree of protection of at least IP20 in accordance with IEC/EN 60529.
3. The Model 3051S enclosure may be made of aluminum alloy and given a protective polyurethane paint finish; however, care should be taken to protect it from impact or abrasion if located in a zone 0 area.

### 8.3.4 ND ATEX Dust

- Certificate** BAS01ATEX1374X
- Standards** EN 60079-0: 2012+A11:2013, EN 60079-31: 2009

**Markings**  II 1 D Ex ta IIIC T105 °C T<sub>500</sub> 95 °C Da, ( $-20\text{ °C} \leq T_a \leq +85\text{ °C}$ ),  $V_{\max} = 42.4\text{ V}$

### Special Conditions for Safe Use (X):

1. Cable entries must be used which maintain the ingress protection of the enclosure to at least IP66.
2. Unused cable entries must be filled with suitable blanking plugs which maintain the ingress protection of the enclosure to at least IP66.
3. Cable entries and blanking plugs must be suitable for the ambient temperature range of the apparatus and capable of withstanding a 7J impact test.
4. The SuperModule(s) must be securely screwed in place to maintain the ingress protection of the enclosure(s).

## 8.3.5 N1 ATEX Type n

**Certificate** BAS01ATEX3304X

**Standards** EN 60079-0: 2012+A11:2013, EN 60079-15: 2010

**Markings**  II 3 G Ex nA IIC T5 Gc, ( $-40\text{ °C} \leq T_a \leq +85\text{ °C}$ ),  $V_{\max} = 45\text{ V}$

### Special Condition for Safe Use (X):

1. The equipment is not capable of withstanding the 500 V insulation test required by clause 6.5 of EN 60079-15:2010. This must be taken into account when installing the equipment.

---

#### Note

RTD Assembly is not included with the 3051SFx Type n Approval.

---

## 8.4 International

### 8.4.1 E7 IECEx Flameproof and Dust

**Certificate** IECEx KEM 08.0010X (Flameproof)

**Standards** IEC 60079-0:2011, IEC 60079-1:2014, IEC 60079-26:2014

**Markings** Ex db IIC T6...T4 Ga/Gb, T6( $-60\text{ °C} \leq T_a \leq +70\text{ °C}$ ), T5/T4( $-60\text{ °C} \leq T_a \leq +80\text{ °C}$ )

**Table 8-4: Process Temperature**

Temperature class	Process temperature
T6	-60 °C to +70 °C



**Table 8-4: Process Temperature (continued)**

Temperature class	Process temperature
T5	-60 °C to +80 °C
T4	-60 °C to +120 °C

**Special Conditions for Safe Use (X):**

1. This device contains a thin wall diaphragm less than 1 mm thickness that forms a boundary between EPL Ga (process connection) and EPL Gb (all other parts of the equipment). The model code and datasheet are to be consulted for details of the diaphragm material. Installation, maintenance and use shall take into account the environmental conditions to which the diaphragm will be subjected. The manufacturer's instructions for installation and maintenance shall be followed in detail to assure safety during its expected lifetime.
2. Flameproof joints are not intended for repair.
3. Non-standard paint options may cause risk from electrostatic discharge. Avoid installations that could cause electrostatic buildup on painted surfaces, and only clean the painted surfaces with a damp cloth. If paint is ordered through a special option code, contact the manufacturer for more information.
4. Appropriate cable, glands and plugs need to be suitable for a temperature of 5 °C greater than maximum specified temperature for location where installed.

**Certificate** IECEx BAS 09.0014X (Dust)

**Standards** IEC 60079-0:2011, IEC 60079-31:2008

**Markings** Ex ta IIIC T105 °C T50095 °C Da, ( $-20\text{ °C} \leq T_a \leq +85\text{ °C}$ ),  
 $V_{\max} = 42.4\text{ V}$

**Special Conditions for Safe Use (X):**

1. Cable entries must be used which maintain the ingress protection of the enclosure to at least IP66.
2. Unused cable entries must be filled with suitable blanking plugs which maintain the ingress protection of the enclosure to at least IP66.
3. Cable entries and blanking plugs must be suitable for the ambient temperature range of the apparatus and capable of withstanding a 7J impact test.

- The 3051S SuperModule must be securely screwed in place to maintain the ingress protection of the enclosure.

#### 8.4.2 I7 IECEx Intrinsic Safety

<b>Certificate</b>	IECEx BAS 04.0017X
<b>Standards</b>	IEC 60079-0: 2011, IEC 60079-11: 2011
<b>Markings</b>	Ex ia IIC T4 Ga, T4(-60 °C ≤ T <sub>a</sub> ≤ +70 °C)

**Table 8-5: Input Parameters**

	U <sub>i</sub>	I <sub>i</sub>	P <sub>i</sub>	C <sub>i</sub>	L <sub>i</sub>
SuperModule	30 V	300 mA	1.0 W	30 nF	0
3051S...A; 3051SF...A; 3051SAL...C	30 V	300 mA	1.0 W	12 nF	0
3051S...F; 3051SF...F	30 V	300 mA	1.3 W	0	0
3051S ...A...M7, M8, or M9; 3051SF ...A... M7, M8, or M9; 3051SAL...C... M7, M8, or M9	30 V	300 mA	1.0 W	12 nF	60 μH
3051SAL or 3051SAM	30 V	300 mA	1.0 W	12 nF	33 μH
3051SAL...M7, M8, or M9 3051SAM...M7, M8, or M9	30 V	300 mA	1.0 W	12 nF	93 μH
RTD Option for 3051SF	5 V	500 mA	0.63 W	N/A	N/A

#### Special Conditions for Safe Use (X):

- The Model 3051S Transmitters fitted with transient protection are not capable of withstanding the 500 V test as defined in Clause 6.3.13 of EN 60079-11:2012. This must be taken into account during installation.
- The terminal pins of the Model 3051S SuperModule must be provided with a degree of protection of at least IP20 in accordance with IEC/EN 60529.
- The Model 3051S enclosure may be made of aluminum alloy and given a protective polyurethane paint finish; however, care should be taken to protect it from impact or abrasion if located in a zone 0 area.

### 8.4.3 I7 IECEx Intrinsic Safety - Group I - Mining (I7 with Special A0259)

<b>Certificate</b>	IECEx TSA 14.0019X
<b>Standards</b>	IEC 60079-0: 2011, IEC 60079-11: 2011
<b>Markings</b>	Ex ia I Ma ( $-60\text{ }^{\circ}\text{C} \leq T_a \leq +70\text{ }^{\circ}\text{C}$ )

**Table 8-6: Input Parameters**

	$U_i$	$I_i$	$P_i$	$C_i$	$L_i$
SuperModule	30 V	300 mA	1.0 W	30 nF	0
3051S...A; 3051SF...A; 3051SAL...C	30 V	300 mA	1.0 W	12 nF	0
3051S...F; 3051SF...F	30 V	300 mA	1.3 W	0	0
3051S ...A...M7, M8, or M9; 3051SF ...A... M7, M8, or M9; 3051SAL...C... M7, M8, or M9	30 V	300 mA	1.0 W	12 nF	60 $\mu\text{H}$
3051SAL or 3051SAM	30 V	300 mA	1.0 W	12 nF	33 $\mu\text{H}$
3051SAL...M7, M8, or M9 3051SAM...M7, M8, or M9	30 V	300 mA	1.0 W	12 nF	93 $\mu\text{H}$
RTD Option for 3051SF	5 V	500 mA	0.63 W	N/A	N/A

#### Special Conditions for Safe Use (X):

1. If the apparatus is fitted with optional 90 V transient suppressor, it is not capable of withstanding the 500 V insulation test required by Clause 6.3.13 of IEC60079-11. This must be taken into account when installing the apparatus.
2. It is a condition of safe use that the above input parameters shall be taken into account during installation.
3. It is a condition of manufacture that only the apparatus fitted with housing, covers and sensor module housing made out of stainless steel are used in Group I applications.

### 8.4.4 IG IECEx FISCO

<b>Certificate</b>	IECEx BAS 04.0017X
<b>Standards</b>	IEC 60079-0: 2011, IEC 60079-11: 2011
<b>Markings</b>	Ex ia IIC T4 Ga, T4( $-60\text{ }^{\circ}\text{C} \leq T_a \leq +70\text{ }^{\circ}\text{C}$ )

**Table 8-7: Input Parameters**

Parameter	FISCO
Voltage $U_i$	17.5 V
Current $I_i$	380 mA
Power $P_i$	5.32 W
Capacitance $C_i$	0
Inductance $L_i$	0

**Special Conditions for Safe Use (X):**

1. The Model 3051S Transmitters fitted with transient protection are not capable of withstanding the 500 V test as defined in Clause 6.3.13 of EN 60079-11:2012. This must be taken into account during installation.
2. The terminal pins of the Model 3051S SuperModule must be provided with a degree of protection of at least IP20 in accordance with IEC/EN 60529.
3. The Model 3051S enclosure may be made of aluminum alloy and given a protective polyurethane paint finish; however, care should be taken to protect it from impact or abrasion if located in a zone 0 area.

**8.4.5 IG IECEx Intrinsic Safety - Group I - Mining (IG with Special A0259)****Certificate** IECEx TSA 04.0019X**Standards** IEC 60079-0: 2011, IEC 60079-11: 2011**Markings** FISCO FIELD DEVICE Ex ia I Ma , ( $-60\text{ }^{\circ}\text{C} \leq T_a \leq +70\text{ }^{\circ}\text{C}$ )**Table 8-8: Input Parameters**

Parameter	FISCO
Voltage $U_i$	17.5 V
Current $I_i$	380 mA
Power $P_i$	5.32 W
Capacitance $C_i$	0
Inductance $L_i$	0

**Special Conditions for Safe Use (X):**

1. If the apparatus is fitted with optional 90 V transient suppressor, it is not capable of withstanding the 500 V insulation test required by

Clause 6.3.13 of IEC60079-11. This must be taken into account when installing the apparatus.

2. It is a condition of safe use that the above input parameters shall be taken into account during installation.
3. It is a condition of manufacture that only the apparatus fitted with housing, covers and sensor module housing made out of stainless steel are used in Group I applications.

#### 8.4.6 N7 IECEx Type n

<b>Certificate</b>	IECEx BAS 04.0018X
<b>Standards</b>	IEC 60079-0: 2011, IEC 60079-15: 2010
<b>Markings</b>	Ex nA IIC T5 Gc, $(-40^{\circ}\text{C} \leq T_a \leq +85^{\circ}\text{C})$

##### Special Condition for Safe Use (X):

1. The equipment is not capable of withstanding the 500 V insulation test required by clause 6.5 of EN 60079-15:2010. This must be taken into account when installing the equipment.

## 8.5 Brazil

### 8.5.1 E2 INMETRO Flameproof

<b>Certificate</b>	UL-BR 15.0393X
<b>Standards</b>	ABNT NBR IEC 60079-0:2008 + Corrigendum 1:2011, ABNT NBR IEC 60079-1:2009 + Corrigendum 1:2011, ABNT NBR IEC 60079-26:2008 + Corrigendum 1: 2008
<b>Markings</b>	Ex db IIC T* Ga/Gb, T6 $(-60^{\circ}\text{C} \leq T_a \leq +70^{\circ}\text{C})$ , T5/T4 $(-60^{\circ}\text{C} \leq T_a \leq +80^{\circ}\text{C})$ , IP66

##### Special Conditions for Safe Use (X):

1. The device contains a thin wall diaphragm less than 1 mm thick that forms a boundary between zone 0 (process connection) and zone 1 (all other parts of the equipment). The model code and datasheet are to be consulted for details of the diaphragm material. Installation, maintenance, and use shall take into account the environmental conditions to which the diaphragm will be subjected. The manufacturer's instructions for maintenance shall be followed in detail to assure safety during its expected lifetime.
2. Flameproof joints are not intended for repair.
3. Non-standard paint options may cause risk from electrostatic discharge. Avoid installations that could cause electrostatic buildup on painted surfaces, and only clean the painted surfaces with a damp

cloth. If paint is ordered through a special option code, contact the manufacturer for more information.

## 8.5.2 I2/IB INMETRO Intrinsic Safety/FISCO

**Certificate** UL-BR 15.0392X

**Standards** ABNT NBR IEC 60079-0:2013, ABNT NBR IEC 60079-11:2013

**Markings** Ex ia IIC T4 Ga ( $-60\text{ }^{\circ}\text{C} \leq T_a \leq +70\text{ }^{\circ}\text{C}$ ), IP66

### Special Conditions for Safe Use (X):

1. The surface resistivity of the antenna is greater than 1 GΩ. To avoid electrostatic charge buildup, it must not be rubbed or cleaned with solvents or a dry cloth.
2. The Model 701PBKCF Power Module may be replaced in a hazardous area. The Power Module has a surface resistivity greater than 1 GΩ and must be properly installed in the wireless device enclosure. Care must be taken during transportation to and from the point of installation to prevent electrostatic charge buildup.
3. The 3051S enclosure may be made of aluminium alloy and given a protective polyurethane paint finish; however, care should be taken to protect it from impact or abrasion if located in areas that requires EPL Ga.

**Table 8-9: Input Parameters**

	$U_i$	$I_i$	$P_i$	$C_i$	$L_i$
SuperModule	30 V	300 mA	1.0 W	30 nF	0
3051S...A; 3051SF...A; 3051SAL...C	30 V	300 mA	1.0 W	12 nF	0
3051S...F; 3051SF...F	30 V	300 mA	1.3 W	0	0
3051S...F...IB; 3051SF...F...IB	17.5 V	380mA	5.32 W	0	0
3051S ...A...M7, M8, or M9; 3051SF ...A... M7, M8, or M9; 3051SAL...C... M7, M8, or M9	30 V	300 mA	1.0 W	12 nF	60 μH
3051SAL or 3051SAM	30 V	300 mA	1.0 W	12 nF	33 μH
3051SAL... M7, M8, or M9 3051SAM... M7, M8, or M9	30 V	300 mA	1.0 W	12 nF	93 μH

**Table 8-9: Input Parameters (continued)**

	<b>U<sub>i</sub></b>	<b>I<sub>i</sub></b>	<b>P<sub>i</sub></b>	<b>C<sub>i</sub></b>	<b>L<sub>i</sub></b>
RTD Option for 3051SF	5 V	500 mA	0.63 W	N/A	N/A

## 8.6 China

### 8.6.1 E3 China Flameproof and Dust Ignition-proof

**Certificate** 3051S: GYJ16.1249X  
 3051SFx: GYJ16.1466X  
 3051S-ERS: GJY15.1406X

**Standards** 3051S: GB3836.1-2010, GB3836.2-2010, GB3836.20-2010, GB12476.1-2013, GB12476.5-2013  
 3051SFx: GB3836.1-2010, GB3836.2-2010, GB3836.20-2010, GB12476.1-2013, GB 12476.5-2013  
 3051S-ERS: GB3836.1-2010, GB3836.2-2010, GB3836.20-2010

**Markings** 3051S: Ex d IIC T6...T4; Ex tD A20 T105 °C T<sub>500</sub> 95 °C; IP66  
 3051SFx: Ex d IIC T4~T6 Ga/Gb; Ex tD A20 IP66 T105 °C T<sub>500</sub> 95 °C; IP66  
 3051S-ERS: Ex d IIC T4~T6 Ga/Gb

### 8.6.2 I3 China Intrinsic Safety

**Certificate** 3051S: GYJ16.1250X [Mfg USA, China, Singapore]  
 3051SFx: GYJ16.1465X [Mfg USA, China, Singapore]  
 3051S-ERS: GYJ16.1248X [Mfg USA, China, Singapore]

**Standards** 3051S: GB3836.1-2010, GB3836.4-2010, GB3836.20-2010  
 3051SFx: GB3836.1/4-2010, GB3836.20-2010, GB12476.1-2013, GB12476.5-2013  
 3051S-ERS: GB3836.1-2010, GB3836.4-2010, GB3836.20-2010

**Markings** 3051S: Ex ia IIC T4 Ga  
 3051SFx: Ex ia IIC T4 Ga, Ex tD A20 IP66 T105 °C T<sub>500</sub> 95 °C  
 3051S-ERS: Ex ia IIC T4 Ga

### 8.6.3 N3 China Type n

**Certificate** 3051S, 3051SHP: GYJ17.1354X

3051SFX: GYJ17.1355X

**Markings** Ex nA IIC T5 Gc

## 8.7 EAC - Belarus, Kazakhstan, Russia

### 8.7.1 EM Technical Regulation Customs Union (EAC) Flameproof and Dust Ignition-proof

**Certificate** RU C-US.AA87.B.00378**Markings** Ga/Gb Ex d IIC T6...T4 X  
Ex tb IIIC T105 °C T<sub>500</sub> 95 °C Db X  
Ex ta IIIC T105 °C T<sub>500</sub> 95 °C Da X

### 8.7.2 IM Technical Regulation Customs Union (EAC) Intrinsic Safety

**Certificate** RU C-US.AA87.B.00378**Markings** 0Ex ia IIC T4 Ga X

### 8.7.3 IN Technical Regulation Customs Union (EAC) Intrinsic Safety

**Certificate:** RU C-US.AA87.B.00378**Markings:** 0Ex ia IIC T4 Ga X

## 8.8 Japan

### 8.8.1 E4 Japan Flameproof

**Certificate** CML 17JPN1147X**Markings** Ex d IIC T6...T4 Ga/Gb

Temperature class	Ambient temperature	Process temperature
T6	-40 °C to +70 °C	-60 °C to +70 °C
T5	-40 °C to +75 °C	-60 °C to +80 °C
T4	-40 °C to +75 °C	-60 °C to +120 °C

#### Special Conditions for Safe Use:

1. This device contains a thin wall diaphragm less than 1mm thickness that forms a boundary between EPL Ga (process connection) and EPL Gb (all other parts of the equipment). The model code and datasheet are to be consulted for details of the diaphragm material. Installation, maintenance, and use shall consider the environmental conditions to which the diaphragm will be subjected. The



manufacturer's instructions for installation and maintenance shall be followed in detail to assure safety during its expected lifetime.

2. Flameproof joints are not intended for repair.
3. Non-standard paint options may cause risk from electrostatic discharge. Avoid installations that could cause electrostatic build-up on painted surfaces, and only clean the painted surfaces with a damp cloth. If paint is ordered through a special option code, contact the manufacturer for more information.

## 8.9 Republic of Korea

### 8.9.1 EP Republic of Korea Flameproof

**Certificate** 12-KB4BO-0180X [Mfg USA], 11-KB4BO-0068X [Mfg Singapore]

**Markings** Ex d IIC T6...T4

### 8.9.2 IP Republic of Korea Intrinsic Safety

**Certificate** 12-KB4BO-0202X [HART - Mfg USA], 12-KB4BO-0204X [Fieldbus - Mfg USA], 12-KB4BO-0203X [HART - Mfg Singapore], 13-KB4BO-0296X [Fieldbus - Mfg Singapore]

**Markings** Ex ia IIC T4

## 8.10 Combinations

- K1** Combination of E1, I1, N1, and ND
- K2** Combination of E2 and I2
- K5** Combination of E5 and I5
- K6** Combination of E6 and I6
- K7** Combination of E7, I7, and N7
- KA** Combination of E1, I1, E6, and I6
- KB** Combination of E5, I5, E6, and I6
- KC** Combination of E1, I1, E5, and I5
- KD** Combination of E1, I1, E5, I5, E6, and I6
- KG** Combination of IA, IE, IF, and IG
- KM** Combination of EM and IM
- KP** Combination of EP and IP

## 8.11 Additional Certifications

### 8.11.1 SBS American Bureau of Shipping (ABS) Type Approval

**Certificate** 17-RJ1679518-PDA

**Intended Use** Measure gauge or absolute pressure of liquid, gas or vapor applications on ABS classed vessels, marine, and offshore installations.

### 8.11.2 SBV Bureau Veritas (BV) Type Approval

**Certificate** 31910 BV

**Requirements** Bureau Veritas Rules for the Classification of Steel Ships

**Application** Class Notations: AUT-UMS, AUT-CCS, AUT-PORT and AUT-IMS.

### 8.11.3 SDN Det Norske Veritas (DNV) Type Approval

**Certificate** TAA00000K9

**Intended Use** Det Norske Veritas' Rules for Classification of Ships, High Speed & Light Craft, and Det Norske Veritas' Offshore Standards

#### Application

Location classes	
Type	3051S
Temperature	D
Humidity	B
Vibration	A
EMC	A
Enclosure	D/IP66/IP68

### 8.11.4 SLL Lloyds Register (LR) Type Approval



**Certificate** 11/60002



**Application** Environmental categories ENV1, ENV2, ENV3, and ENV5

### 8.11.5 D3 Custody Transfer - Measurement Canada Accuracy Approval [3051S Only]

**Certificate** AG-0501, AV-2380C

# 9 Rosemount 3051S Declaration of Conformity

	<b>EU Declaration of Conformity</b>	
<b>No: RMD 1044 Rev. AD</b>		
<p>We,</p>		
<p><b>Rosemount Inc. 8200 Market Boulevard Chanhassen, MN 55317-9685 USA</b></p>		
<p>declare under our sole responsibility that the product,</p>		
<p><b>Rosemount 3051S Series Pressure Transmitters Rosmeount 3051SFx Series Flowmeter Transmitters Rosemount 300S Housings</b></p>		
<p>manufactured by,</p>		
<p><b>Rosemount Inc. 8200 Market Boulevard Chanhassen, MN 55317-9685 USA</b></p>		
<p>to which this declaration relates, is in conformity with the provisions of the European Union Directives, including the latest amendments, as shown in the attached schedule.</p>		
<p>Assumption of conformity is based on the application of the harmonized standards and, when applicable or required, a European Union notified body certification, as shown in the attached schedule.</p>		
		
_____ (signature)	_____ <b>Vice President of Global Quality</b> (function name - printed)	
 <b>Chris LaPoint</b> _____ (name - printed)	 <b>1-Feb-19; Shakopee, MN USA</b> _____ (date of issue)	
<p>Page 1 of 4</p>		

 <b>EU Declaration of Conformity</b> No: RMD 1044 Rev. AD	
<b>EMC Directive (2014/30/EU)</b>	
Harmonized Standards: EN 61326-1:2013, EN 61326-2-3:2013	
<b>PED Directive (2014/68/EU)</b>	
<b>Rosemount 3051S Series Pressure Transmitters</b>	
<b>Rosemount 3051S_CA4; 3051S_CD2, 3, 4, 5 (also with P0 &amp; P9 option) Pressure Transmitters</b>	
QS Certificate of Assessment – Certificate No. 12698-2018-CE-USA-ACCREDIA Module H Conformity Assessment Other Standards Used: ANSI / ISA 61010-1:2004 <i>Note – previous PED Certificate No. 59552-2009-CE-HOU-DNV</i>	
<b>All other Rosemount 3051S Pressure Transmitters</b> Sound Engineering Practice	
<b>Transmitter Attachments: Diaphragm Seal, Process Flange, or Manifold</b> Sound Engineering Practice	
<b>Rosemount 3051SFx Series Flowmeter Pressure Transmitters</b> See DSI 1000 Declaration of Conformity	
Page 2 of 4	



# EU Declaration of Conformity



No: RMD 1044 Rev. AD

## ATEX Directive (2014/34/EU)

### BAS01ATEX1303X – Intrinsic Safety Certificate

Equipment Group II, Category 1 G  
 Ex ia IIC T4 Ga  
 Harmonized Standards Used:  
 EN 60079-0:2012+A11:2013, EN 60079-11:2012

### BAS01ATEX3304X – Type n Certificate

Equipment Group II, Category 3 G  
 Ex nA IIC T5 Gc  
 Harmonized Standards Used:  
 EN 60079-0:2012+A11:2013, EN 60079-15:2010

### BAS01ATEX1374X – Dust Certificate

Equipment Group II, Category 1 D  
 Ex ta IIIC T105°C T<sub>500</sub>95°C Da  
 Harmonized Standards Used:  
 EN 60079-0:2012+A11:2013  
 Other Standards Used:  
 EN 60079-31:2009 (a review against EN 60079-31:2014, which is harmonized, shows no significant changes relevant to this equipment so EN 60079-31:2009 continues to represent “State of the Art”)

### BAS04ATEX0181X – Mining Certificate

Equipment Group I, Category M1  
 Ex ia I Ma  
 Harmonized Standards Used:  
 EN 60079-0:2012, EN 60079-11:2012

### BAS04ATEX0193U – Mining Certificate: Component

Equipment Group I, Category M1  
 Ex ia I Ma  
 Harmonized Standards Used:  
 EN 60079-0:2012, EN 60079-11:2012

### KEMA00ATEX2143X – Flameproof Certificate

Equipment Group II, Category 1/2 G  
 Ex db IIC T6...T4 Ga/Gb  
 Harmonized Standards:  
 EN 60079-0:2012+A11:2013, EN 60079-1:2014, EN 60079-26:2015



# EU Declaration of Conformity



No: RMD 1044 Rev. AD

## PED Notified Body

**DNV GL Business Assurance Italia S.r.l.** [Notified Body Number: 0496]  
Via Energy Park, 14, N-20871  
Vimercate (MB), Italy

*Note – equipment manufactured prior to 20 October 2018 may be marked with the previous PED  
Notified Body number; previous PED Notified Body information was as follows:  
Det Norske Veritas (DNV) [Notified Body Number: 0575]  
Veritasveien 1, N-1322  
Hovik, Norway*

## ATEX Notified Bodies for EU Type Examination Certificate

**DEKRA Certification B.V.** [Notified Body Number: 0344]  
Utrechtseweg 310  
Postbus 5185  
6802 ED Arnhem  
Netherlands

**SGS FIMCO OY** [Notified Body Number: 0598]  
P.O. Box 30 (Särkiniementie 3)  
00211 HELSINKI  
Finland

## ATEX Notified Body for Quality Assurance

**SGS FIMCO OY** [Notified Body Number: 0598]  
P.O. Box 30 (Särkiniementie 3)  
00211 HELSINKI  
Finland

## 10 China RoHS

含有China RoHS 管控物质超过最大浓度限值的部件型号列表 Rosemount 3051S  
List of Rosemount 3051S Parts with China RoHS Concentration above MCVs

部件名称 Part Name	有害物质 / Hazardous Substances					
	铅 Lead (Pb)	汞 Mercury (Hg)	镉 Cadmium (Cd)	六价铬 Hexavalent Chromium (Cr +6)	多溴联苯 Polybrominated biphenyls (PBB)	多溴联苯醚 Polybrominated diphenyl ethers (PBDE)
电子组件 Electronics Assembly	X	O	O	O	O	O
壳体组件 Housing Assembly	X	O	O	X	O	O
传感器组件 Sensor Assembly	X	O	O	X	O	O

本表格系依据SJ/T11364的规定而制作。

This table is proposed in accordance with the provision of SJ/T11364.

O: 意为该部件的所有均质材料中该有害物质的含量均低于GB/T 26572所规定的限量要求。

O: Indicate that said hazardous substance in all of the homogeneous materials for this part is below the limit requirement of GB/T 26572.

X: 意为在该部件所使用的所有均质材料里，至少有一类均质材料中该有害物质的含量高于GB/T 26572所规定的限量要求。

X: Indicate that said hazardous substance contained in at least one of the homogeneous materials used for this part is above the limit requirement of GB/T 26572.



### **Global Headquarters**

Emerson Automation Solutions  
6021 Innovation Blvd.  
Shakopee, MN 55379, USA

- +1 800 999 9307 or +1 952 906 8888
- +1 952 204 8889
- RFQ.RMD-RCC@Emerson.com

### **North America Regional Office**

Emerson Automation Solutions  
8200 Market Blvd.  
Chanhassen, MN 55317, USA

- +1 800 999 9307 or +1 952 906 8888
- +1 952 204 8889
- RMT-NA.RCCRFQ@Emerson.com

### **Latin America Regional Office**

Emerson Automation Solutions  
1300 Concord Terrace, Suite 400  
Sunrise, FL 33323, USA

- +1 954 846 5030
- +1 954 846 5121
- RFQ.RMD-RCC@Emerson.com

### **Europe Regional Office**

Emerson Automation Solutions Europe  
GmbH  
Neuhofstrasse 19a P.O. Box 1046  
CH 6340 Baar  
Switzerland

- +41 (0) 41 768 6111
- +41 (0) 41 768 6300
- RFQ.RMD-RCC@Emerson.com

### **Asia Pacific Regional Office**

Emerson Automation Solutions  
1 Pandan Crescent  
Singapore 128461

- +65 6777 8211
- +65 6777 0947
- Enquiries@AP.Emerson.com

### **Middle East and Africa Regional Office**

Emerson Automation Solutions  
Emerson FZE P.O. Box 17033  
Jebel Ali Free Zone - South 2  
Dubai, United Arab Emirates

- +971 4 8118100
- +971 4 8865465
- RFQ.RMTMEA@Emerson.com

 [Linkedin.com/company/Emerson-Automation-Solutions](https://www.linkedin.com/company/Emerson-Automation-Solutions)

 [Twitter.com/Rosemount\\_News](https://twitter.com/Rosemount_News)

 [Facebook.com/Rosemount](https://www.facebook.com/Rosemount)

 [Youtube.com/user/RosemountMeasurement](https://www.youtube.com/user/RosemountMeasurement)

©2019 Emerson. All rights reserved.

Emerson Terms and Conditions of Sale are available upon request. The Emerson logo is a trademark and service mark of Emerson Electric Co. Rosemount is a mark of one of the Emerson family of companies. All other marks are the property of their respective owners.