



model AX13S

AXION Advantage® Upgrade Kit

FEATURES & BENEFITS

EYE/FACE WASH

AXION® MSR eye/face wash head uses an inverted directional laminar flow to sweep contaminants away from the vulnerable nasal cavity.

OPTIONS

For more information, visit www.hawsc.com or call (888) 640-4297.



SPECIFICATIONS

Model AX13S AXION Advantage® stainless steel eye/face wash system shall include the stainless steel AXION® MSR eye/face wash head, stainless steel connecting hardware, ANSI eyewash gauge, tape measure, complete installation instructions and ANSI compliance information. The AXION Advantage system is ANSI compliant when installed correctly based on manufacturer guidelines and when tested against the ANSI Z358.1 checklist included with the product. The materials provided offer complete ANSI compliance tools and instructions. At the current time, ANSI does not regulate product brands, models, or the interchange of product components.

APPLICATIONS

Perfect for installed emergency equipment that might be outdated, under-performing, or potentially out of compliance with the current ANSI Z358.1 standard. Specifically, this system can replace eyewash heads that flow too low or high, unevenly, or uncomfortably. The user will be assured their equipment will comply with ANSI emergency protocol using the best performing eye/face wash head on the market.

PARTS NOT SHOWN BUT SUPPLIED

- AXION EYE/FACE WASH ASSEMBLY
- MEASURING TAPE
- ** - EYEWASH GAUGE
- ANSI MIN. PERFORMANCE CHECKLIST

** NOTE: IF PRESENT, REMOVE PAPER-BACKING PRIOR TO USE.

PARTS BREAKDOWN

IMPORTANT: UNITS MUST BE FULLY TESTED AND CHECKED FOR ANSI COMPLIANCE USING ENCLOSED CHECKLIST AFTER UPGRADING THE INSTALLATION.

* NOTE CORRESPONDING LETTERS ON INSTALLATION DRAWING.

OVERLAY ACTUAL ADAPTERS ON FULL SCALE OUTLINES TO ASSIST WITH ADAPTER IDENTIFICATION PROCESS

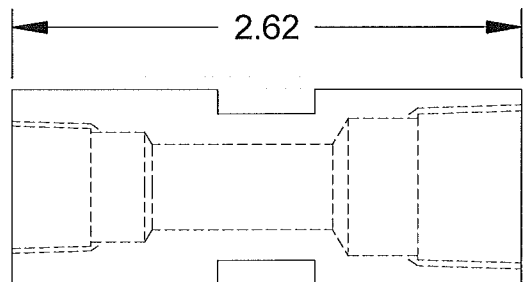

3/8" NPT (F) X 1/2" NPT (F)

(E) *

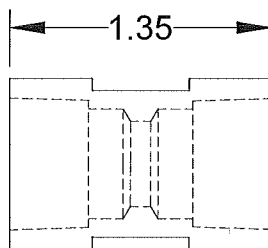

3/8" X 3/8" NPT (F)

(A) *

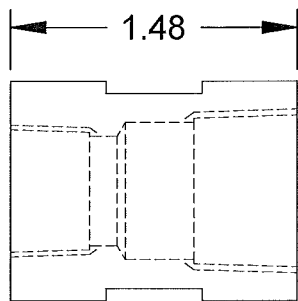

3/8" NPT (F) X 1/2" NPT (F)

(F) *

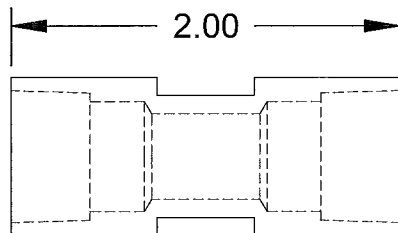

3/8" X 3/8" NPT (F)

(B) *

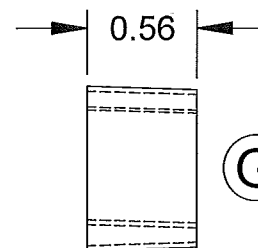

1/2" NPT (M) X 3/8" NPT (F)
(NOTE: IF PRESENT, REMOVE COVER PRIOR TO USE)

(G) *

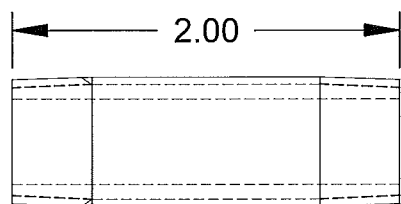

3/8" NPSM 2X 3/8" NPT (M)

(C) *

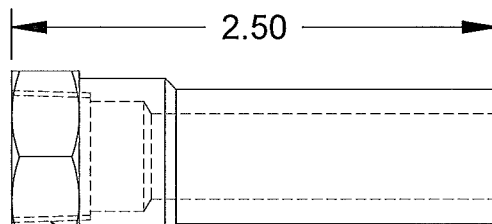

3/8" NPT (F)

(H) *

1/4" NPSM (F)

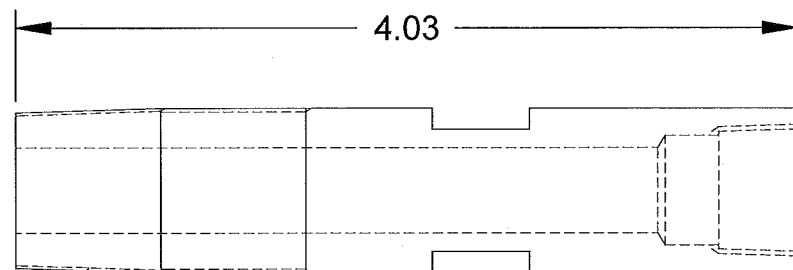

(D) *

3/8" NPT (F)

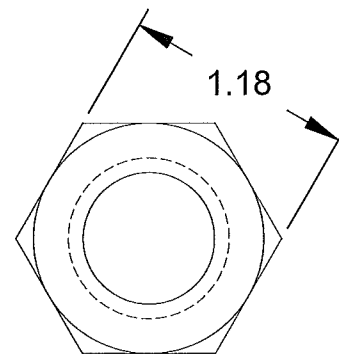

1/2" NPS NUT

1/2" NPT (M) 1/2" NPSM

WHEN ORDERING PARTS PLEASE SPECIFY MODEL NUMBER.

		1455 KLEPPE LANE SPARKS, NEVADA 89431 (775) 359-4712 FAX (775) 359-7424 E-MAIL: HAWS@HAWS.CO.COM WEBSITE: WWW.HAWS.CO.COM	
		ECN NO. 4856 REVISIONS: 1 DATE: 02/09/13 DRAWN BY: H. MERRILL APPROVED BY: [Signature]	MODEL(S) AX13 & AX13S AXION® ADVANTAGE™
SCALE: 1:1		DRAWING TYPE: PARTS BREAKDOWN	SIZE: A SHEET 1 OF 1

TO UPGRADE ACORN UNITS

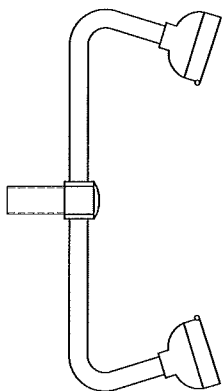

ACORN STANDARD EYEWASH

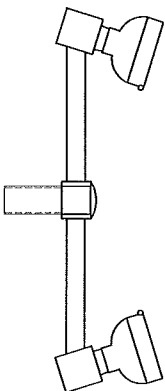

ACORN BARRIER FREE EYEWASH

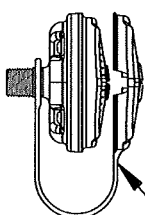

AXION EYEFACE WASH HEAD & DUST COVER (SUPPLIED) SEE CLEANING DETAIL (SHEET 6 OF 6)

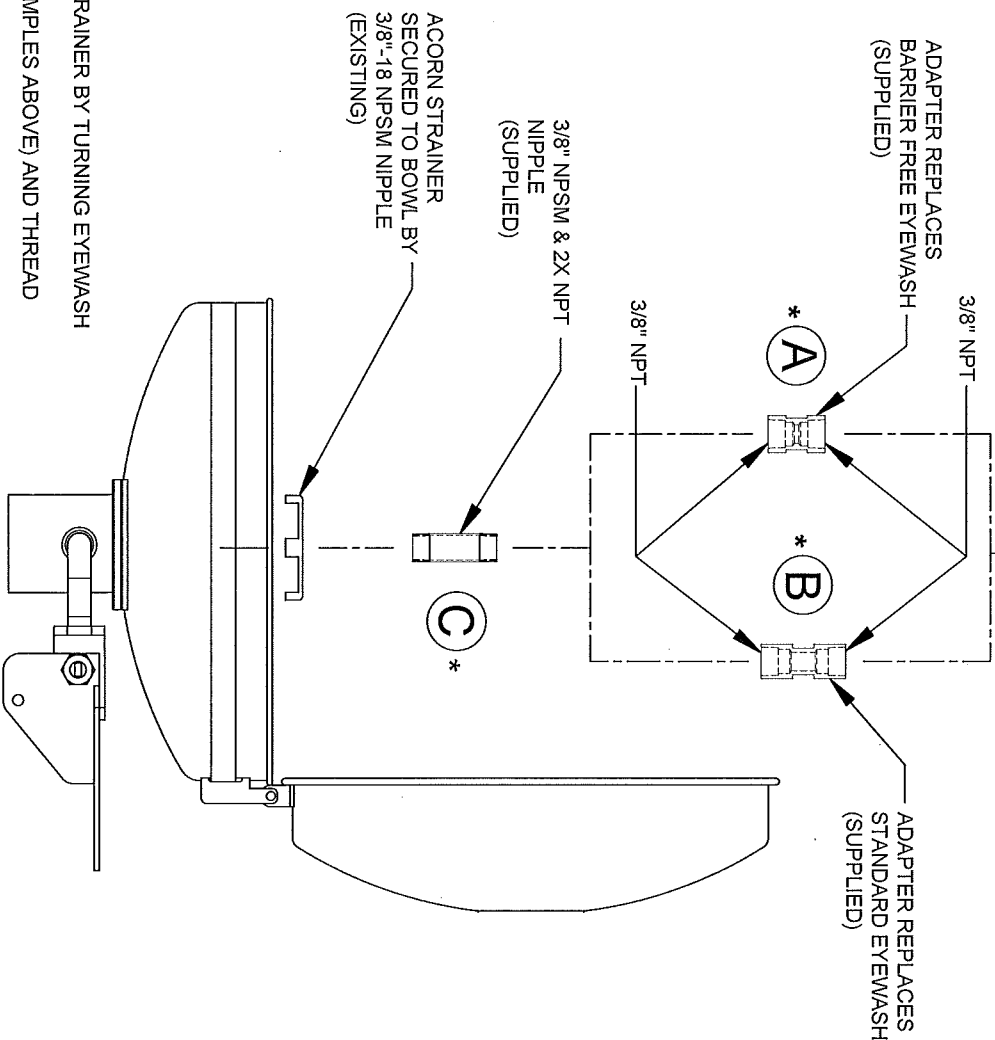

ACORN STRAINER SECURED TO BOWL BY 3/8"-18 NPSM NIPPLE (EXISTING)

NOTES:

NOT FOR USE ON ANY FREEZE RESISTANT UNITS.
 * NOTE CORRESPONDING LETTERS ON PARTS BREAKDOWN DRAWING.

INSTALLATION INSTRUCTIONS:

1. REMOVE EXISTING ACORN EYEWASH ASSEMBLY FROM BOWL AND STRAINER BY TURNING EYEWASH ASSEMBLY COUNTER CLOCKWISE.
2. CONNECT 3/8"-18 NPSM NIPPLE TO APPROPRIATE ADAPTER (SEE EXAMPLES ABOVE) AND THREAD STRAINER ONTO NIPPLE.
3. CONNECT NIPPLE TO BOWL AND TIGHTEN ASSEMBLY USING WRENCH, USE SEALANT AS NECESSARY.
4. UNTHREAD STRAINER (ROTATE CLOCKWISE) UNTIL IT IS SECURE AGAINST BOWL.
5. FLUSH SYSTEM TO REMOVE LINE DEBRIS PRIOR TO INSTALLING AXION PRODUCTS.
6. PLACE AXION EYEFACE WASH SHANK THROUGH DUST COVER LOOP AND CONNECT TO ADAPTER.
7. ORIENT TAB (SEE SHEET 6 OF 6) ON AXION EYEFACE WASH TOWARDS THE BACK (AWAY FROM USER). DO NOT OVER-TIGHTEN.
8. FULLY TEST UNIT AND CHECK FOR ANSI COMPLIANCE USING ENCLOSED CHECKLIST AFTER UPGRADING THE INSTALLATION.

		1455 KLEPPE LANE SPARKS, NEVADA 89431 (775) 359-4712 FAX (775) 359-7424 E-MAIL: HAWS@HAWSCO.COM WEBSITE: WWW.HAWSCO.COM	
EVN NO. REVISED PER BY:	MODEL(S)	AX13 & AX13S	PART NUMBER
4839	EON-4856		0002080247.D
DRAWN BY: J. L. VANCE	DATE: 12/23/11	AXION® ADVANTAGE™	DRAWING NO. 16283A
APPROVED BY: [Signature]	SCALE: 1:1/25	DRAWING TYPE: INSTALLATION	REV 1
	SIZE: A	SHEET: 1	OF: 6

TO UPGRADE ENCON UNITS

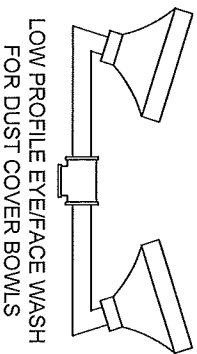
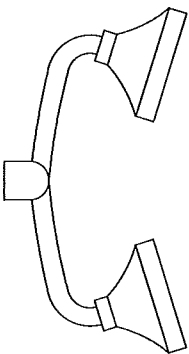
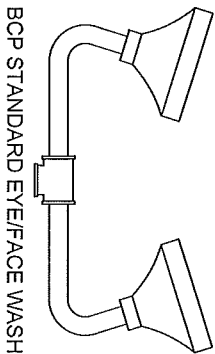

NOTES:
 NOT FOR USE ON ANY FREEZE RESISTANT UNITS.
 * NOTE CORRESPONDING LETTERS ON PARTS BREAKDOWN DRAWING.

INSTALLATION INSTRUCTIONS:

1. REMOVE EXISTING ENCON EYE/FACE WASH ASSEMBLY FROM BOWL BY TURNING EYE/FACE WASH ASSEMBLY COUNTER CLOCKWISE.
2. FOR 3/8" NPT INLET MODELS: CONNECT BUSHING TO 3/8" NPT SUPPLY INLET & CONNECT APPROPRIATE ADAPTER TO BUSHING (SEE EXAMPLES ABOVE). TIGHTEN ASSEMBLY USING WRENCH, USE SEALANT AS NECESSARY.
3. FLUSH SYSTEM TO REMOVE LINE DEBRIS PRIOR TO INSTALLING AXION PRODUCTS.
4. PLACE AXION EYE/FACE WASH SHANK THROUGH DUST COVER LOOP AND CONNECT TO ADAPTER.
5. ORIENT TAB (SEE SHEET 6 OF 6) ON AXION® EYE/FACE WASH TOWARDS THE BACK (AWAY FROM USER), DO NOT OVER-TIGHTEN.
6. FULLY TEST UNIT AND CHECK FOR ANSI COMPLIANCE USING ENCLOSED CHECKLIST AFTER UPGRADING THE INSTALLATION.

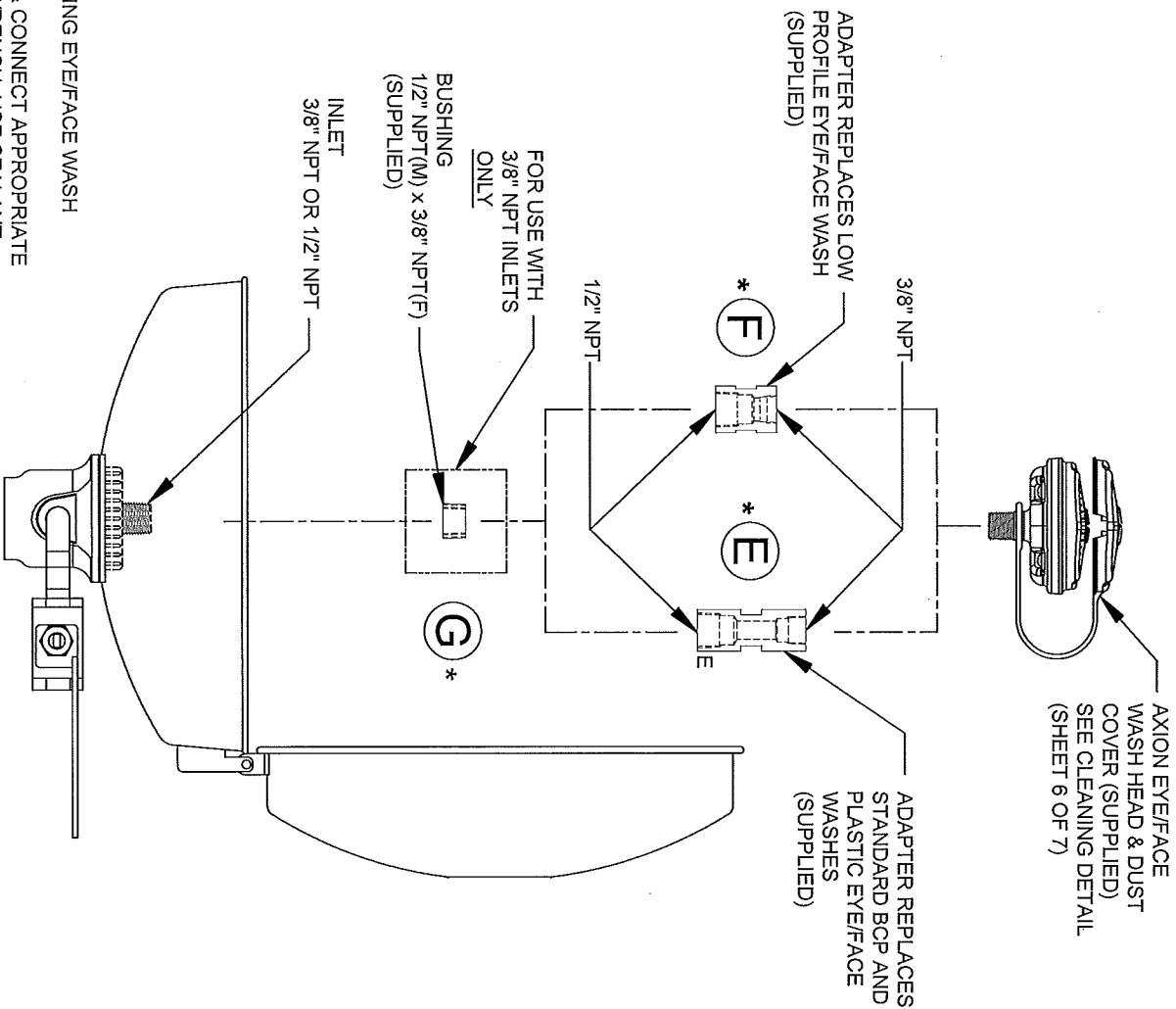

		1455 KLEPPE LANE SPARKS, NEVADA 89431 (775) 359-4712 FAX (775) 359-7424 E-MAIL: HAWS@HAWSCCO.COM WEBSITE: WWW.HAWSCCO.COM	
EQ'NO. REQ'D	REVISED BY	MODEL(S)	PART NUMBER
4393	ENR/448	AX13 & AX13S	0002050247.D
DRAWN	DATE	AXION® ADVANTAGE™	DRAWING NO.
A. MACK	10/2014		16283A
APPROVED	DATE	INSTALLATION	REV
	10/14		1
SCALE	1:1.125	DRAWING TYPE	SIZE
			A SHEET 2 OF 6

TO UPGRADE GUARDIAN UNITS

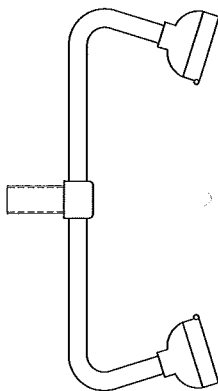

GUARDIAN STANDARD EYEWASH

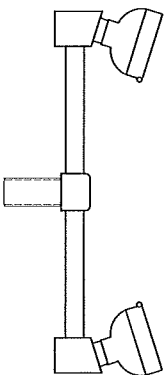

GUARDIAN DUST COVER EYEWASH

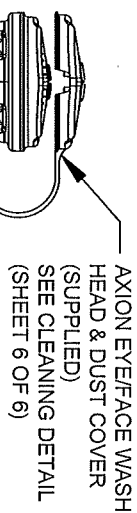

AXION EYEFACE WASH HEAD & DUST COVER (SUPPLIED) SEE CLEANING DETAIL (SHEET 6 OF 6)

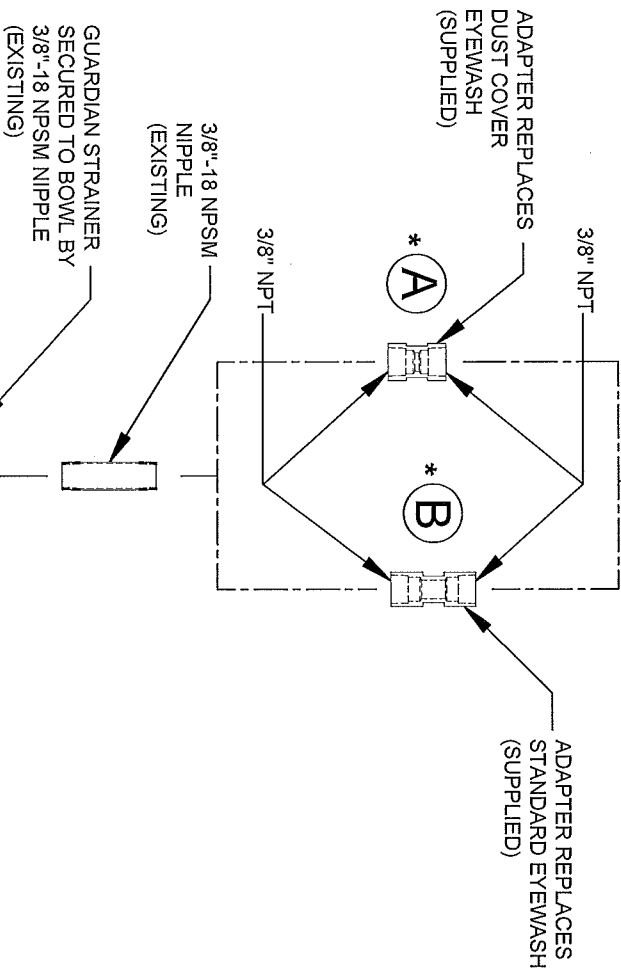

NOTE:
 NOT FOR USE ON ANY FREEZE RESISTANT UNITS.
 * NOTE CORRESPONDING LETTERS ON PARTS BREAKDOWN DRAWING.

INSTALLATION INSTRUCTIONS:

1. REMOVE EXISTING GUARDIAN EYEWASH ASSEMBLY FROM BOWL AND STRAINER BY TURNING EYEWASH ASSEMBLY COUNTER CLOCKWISE.
2. CONNECT EXISTING 3/8"-18 NPSM NIPPLE TO APPROPRIATE ADAPTER (SEE EXAMPLES ABOVE) AND THREAD STRAINER ONTO NIPPLE.
3. CONNECT NIPPLE TO BOWL AND TIGHTEN ASSEMBLY USING WRENCH, USING SEALANT AS NECESSARY.
4. UNTHREAD STRAINER (ROTATE CLOCKWISE) UNTIL SECURE AGAINST BOWL.
5. FLUSH SYSTEM TO REMOVE DEBRIS PRIOR TO INSTALLING AXION PRODUCTS.
6. PLACE AXION EYEFACE WASH SHANK THROUGH DUST COVER LOOP AND CONNECT TO ADAPTER. USER, DO NOT OVER-TIGHTEN!
7. ORIENT TAB (SEE SHEET 6 OF 6) ON AXION EYEFACE WASH TOWARDS THE BACK (AWAY FROM FULLY TEST UNIT AND CHECK FOR ANSI COMPLIANCE USING ENCLOSED CHECKLIST AFTER UPGRADING THE INSTALLATION.

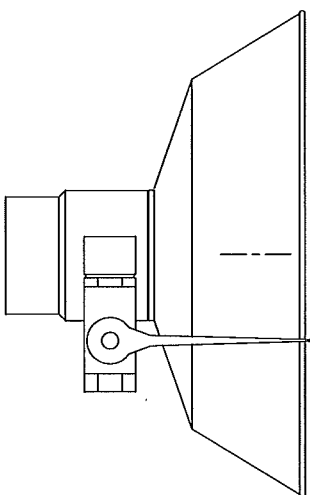

1455 KLEPPE LANE
 SPARKS, NEVADA 89431
 (775) 359-4712 FAX (775) 359-7424
 E-MAIL: HAWS@HAWSCCO.COM
 WEBSITE: WWW.HAWSCCO.COM

EQ. NO. REVISED PER:	MODEL(S)	PART NUMBER
DATE	AX13 & AX13S	0002080247.D
DRAWN BY	AXION® ADVANTAGE™	DRAWING NO.
APPROVED		16283A
SCALE: 1:1.25	DRAWING TYPE: INSTALLATION	SIZE: A
		SHEET 3 OF 6

TO UPGRADE SPEAKMAN UNITS

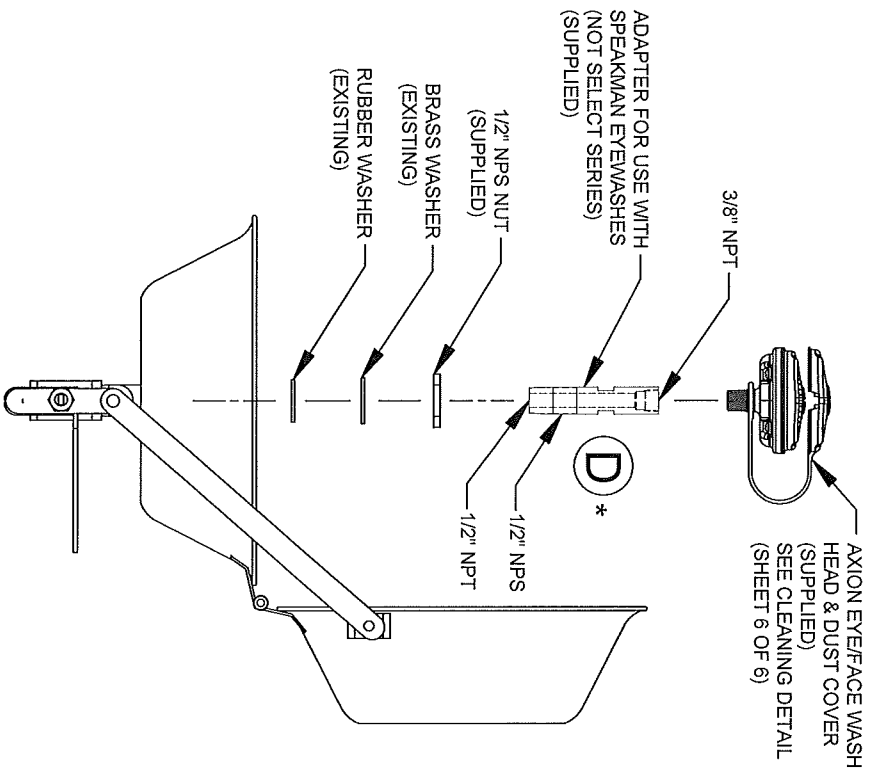

NOTE:
NOT FOR USE ON ANY FREEZE RESISTANT UNITS.
* NOTE CORRESPONDING LETTERS ON PARTS BREAKDOWN DRAWING.

INSTALLATION INSTRUCTIONS:

1. REMOVE EXISTING SPEAKMAN EYEWASH ASSEMBLY FROM BOWL BY TURNING EYEWASH ASSEMBLY COUNTER CLOCKWISE.
2. FULLY THREAD 1/2" NPS NUT ONTO ADAPTER.
3. ASSEMBLE ADAPTER AND WASHERS AS SHOWN ABOVE.
4. CONNECT ADAPTER TO BOWL AND TIGHTEN USING WRENCH TO TURN THE ADAPTER. USE SEALANT AS NECESSARY.
5. FLUSH SYSTEM TO REMOVE LINE DEBRIS PRIOR TO INSTALLING AXION PRODUCTS.
6. UNTHREAD 1/2" NPS NUT (CLOCKWISE ROTATION) TO SECURE THE ADAPTER TO THE BOWL AND COMPRESS WASHERS AND SEAL BOWL. CHECK FOR LEAKS AFTER INSTALLING.
7. PLACE AXION EYEFACE WASH SHANK THROUGH DUST COVER LOOP AND CONNECT TO ADAPTER.
8. ORIENT TAB (SEE SHEET 6 OF 6) ON AXION EYEFACE WASH TOWARDS THE BACK (AWAY FROM USER). DO NOT OVER-TIGHTEN.
9. FULLY TEST UNIT AND CHECK FOR ANSI COMPLIANCE USING ENCLOSED CHECKLIST AFTER UPGRADING THE INSTALLATION.

TO UPGRADE BRADLEY UNITS

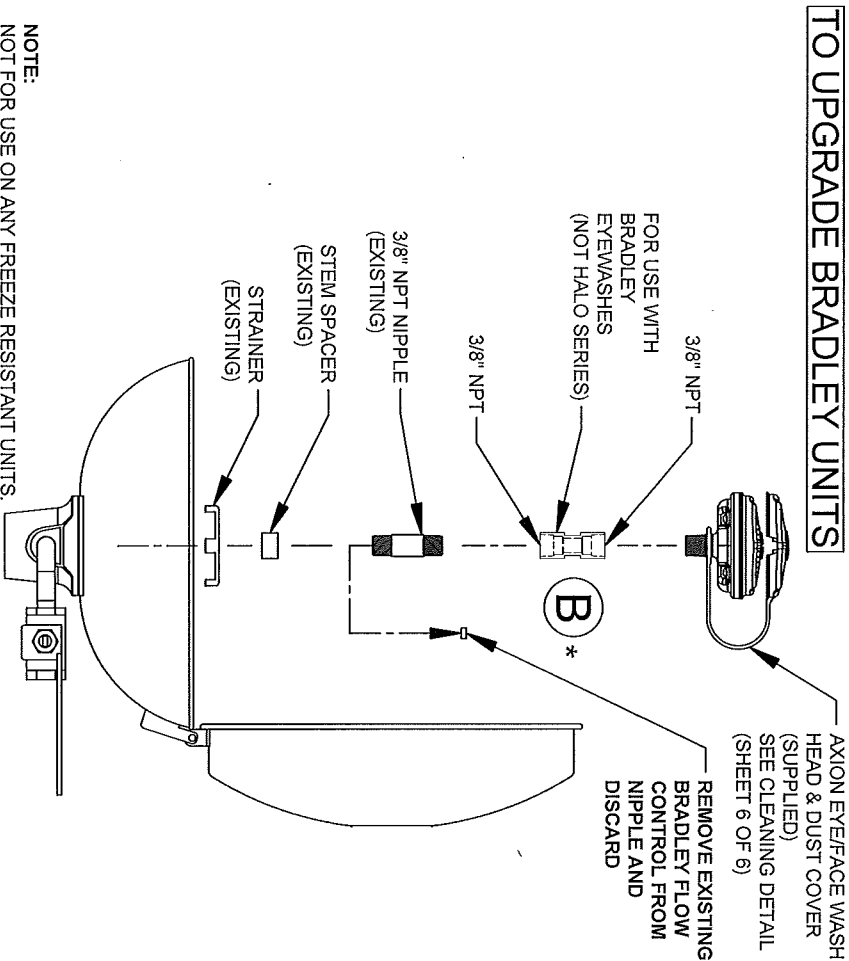

NOTE:
NOT FOR USE ON ANY FREEZE RESISTANT UNITS.
* NOTE CORRESPONDING LETTERS ON PARTS BREAKDOWN DRAWING.

INSTALLATION INSTRUCTIONS:

1. REMOVE EXISTING BRADLEY EYEWASH ASSEMBLY FROM BOWL BY TURNING EYEWASH ASSEMBLY COUNTER CLOCKWISE.
2. SEPARATE 3/8" NPT NIPPLE. REMOVE PLASTIC FLOW CONTROL IN THE BOTTOM OF THE NIPPLE AND DISCARD.
3. CONNECT 3/8" NPT NIPPLE TO ADAPTER AND ASSEMBLE THE ADAPTER, NIPPLE, STEM SPACER, AND STRAINER AS SHOWN ABOVE.
4. CONNECT NIPPLE TO BOWL AND TIGHTEN ASSEMBLY USING WRENCH. USE SEALANT AS NECESSARY.
5. FLUSH SYSTEM TO REMOVE LINE DEBRIS PRIOR TO INSTALLING AXION PRODUCTS.
6. PLACE AXION EYEFACE WASH SHANK THROUGH DUST COVER LOOP AND CONNECT TO ADAPTER.
7. ORIENT TAB (SEE SHEET 6 OF 6) ON AXION EYEFACE WASH TOWARDS THE BACK (AWAY FROM USER). DO NOT OVER-TIGHTEN.
8. FULLY TEST UNIT AND CHECK FOR ANSI COMPLIANCE USING ENCLOSED CHECKLIST AFTER UPGRADING THE INSTALLATION.



1455 KLEPPE LANE
SPARKS, NEVADA 89431
(775) 359-4712 FAX (775) 359-7424
E-MAIL: HAWS@HAWS.CO.COM
WEBSITE: WWW.HAWS.CO.COM

ECN NO. 4899	ECN-4899	MODEL(S)	AX13 & AX13S
DRAWN: J. MACK	DATE: 02/21/13	CHECKED: J. MACK	AXION@ADVANTAGE™
APPROVED: J. MACK	SCALE: 1:125	DRAWING TYPE: INSTALLATION	PART NUMBER: 0002080247-D
	SIZE: A	SHEET: 4 OF 6	DRAWING NO.: 16283A
			REV: 1

TO UPGRADE HAWS UNITS

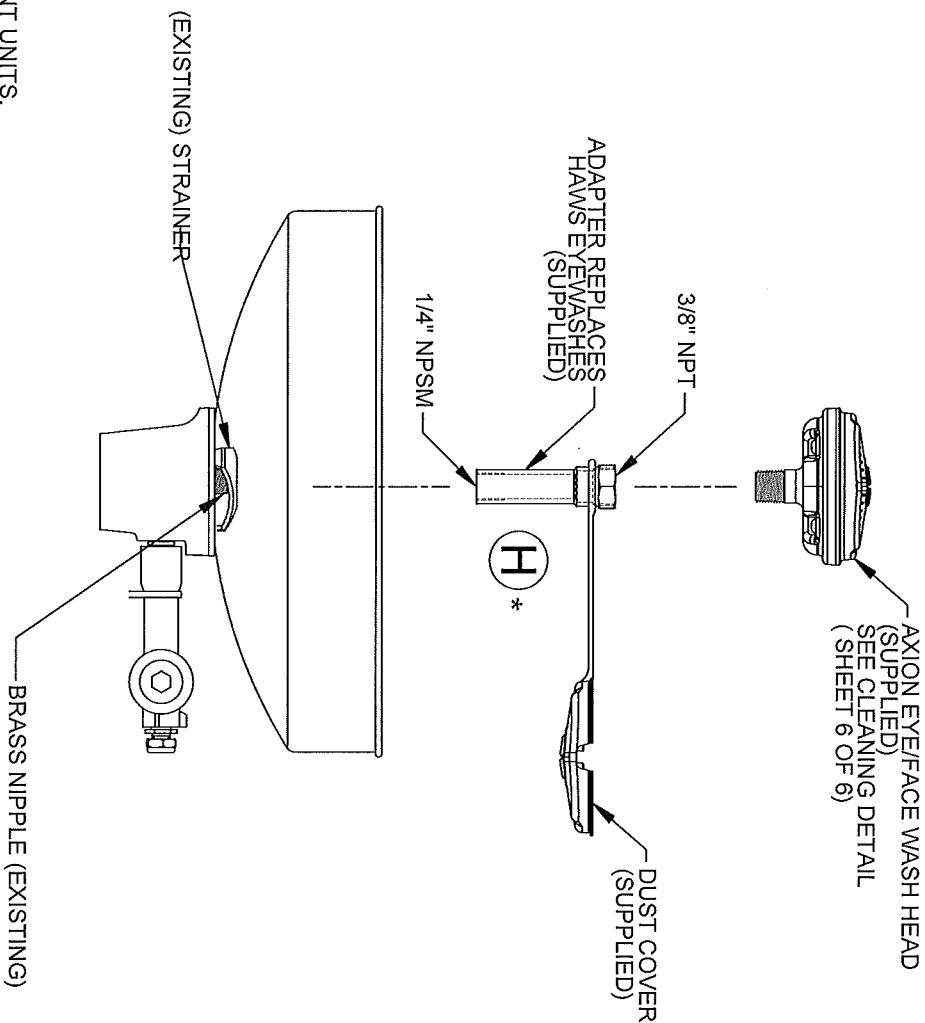

NOTE:
 NOT FOR USE ON ANY FREEZE RESISTANT UNITS.
 *NOTE CORRESPONDING LETTERS ON PARTS BREAKDOWN DRAWING.

INSTALLATION INSTRUCTIONS:

1. REMOVE EXISTING HAWS EYEWASH ASSEMBLY FROM BOWL BY TURNING EYEWASH ASSEMBLY COUNTER CLOCKWISE. DO NOT REMOVE SUPPLY NIPPLE FROM BOWL HOLDER.
2. PLACE HAWS ADAPTER THROUGH DUST COVER LOOP. THREAD HAWS ADAPTER ONTO SUPPLY NIPPLE UNTIL SNUG AGAINST EXISTING STRAINER. USE SEALANT AS NECESSARY.
3. FLUSH SYSTEM TO REMOVE LINE DEBRIS PRIOR TO INSTALLING AXION PRODUCTS.
4. THREAD AXION EYE/FACE WASH ONTO ADAPTER. ORIENT TAB (SEE SHEET 6 OF 6) TOWARDS THE BACK (AWAY FROM THE USER). DO NOT OVER TIGHTEN.
5. PLACE DUST COVER ONTO EYE/FACE WASH.
6. SUPPLIED HAWS ADAPTER MAY NOT BE REQUIRED IN SOME APPLICATIONS.
7. FULLY TEST UNIT AND CHECK FOR ANSI COMPLIANCE USING ENCLOSED CHECKLIST AFTER UPGRADING THE INSTALLATION.

		1465 KLEPPELANE SPARKS, NEVADA 89431 (775) 399-4712 FAX (775) 399-7424 E-MAIL: HAWS@HAWS.CO.COM WEBSITE: WWW.HAWS.CO.COM	
ECN NO. REVISED PER B.Y. 4839 ECN: 4855	MODEL(S) AX13 & AX13S	DRAWING NO. 16283A	PART NUMBER 0002080247 D
DATE: 10/18/12 DRAWN BY: J. MACK	AXION® ADVANTAGE™	DRAWING NO. 16283A	REV 1
SCALE: 1:2	DRAWING TYPE: INSTALLATION	SIZE: A	SHEET: 5 OF 6

EYE/FACE WASH HEAD HAS 2 LARGE OPENINGS (FOR EYES) AND MULTIPLE SMALLER OPENINGS (FOR FACEWASH) [2] [5]

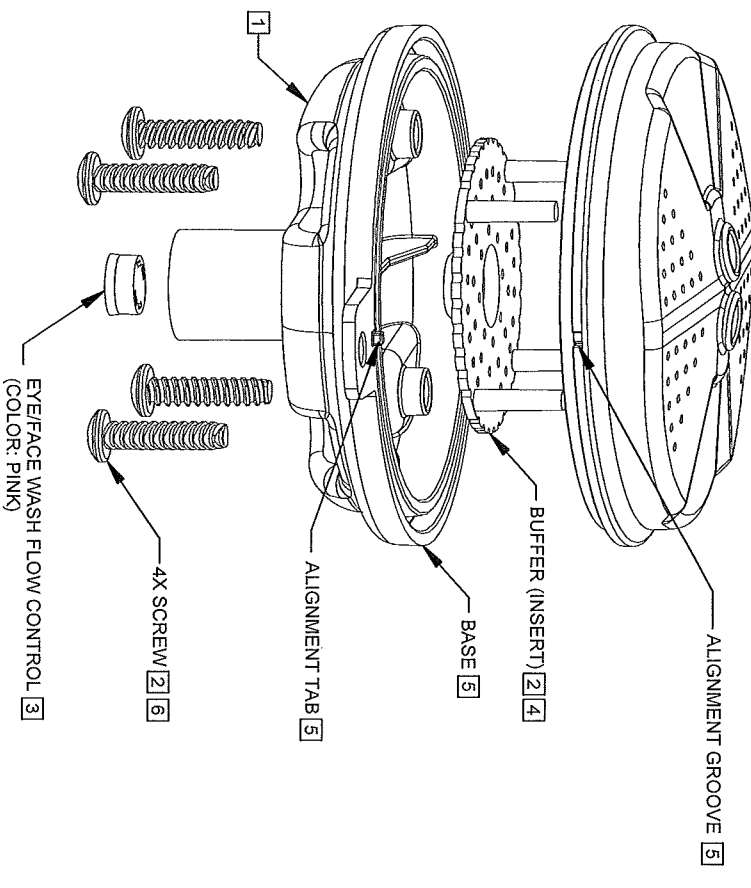

FLOW CONTROL SHOWN IN PLACE
NOTE: PRESS FLOW CONTROL IN UNTILL IT BOTTOMS OUT

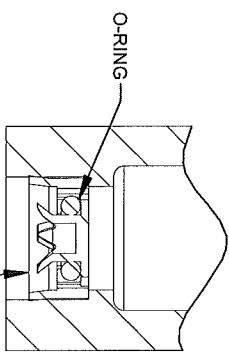

3 DETAIL A

AXION EYE/FACE WASH CLEANING DETAIL

FLOW CONTROL CLEANING STEPS:

- 1 UNSCREW EYE/FACE WASH ASSEMBLY FROM ADAPTER (NOT SHOWN).
- 2 REMOVE SCREWS (QTY. 4) FROM EYE/FACE WASH ASSEMBLY. REMOVE EYE/FACE WASH HEAD AND BUFFER (INSERT).
- 3 REMOVE EXISTING FLOW CONTROL FROM BASE BY PUSHING IT OUT FROM THE TOP, AND CAREFULLY REMOVE ANY DEBRIS LODGED BETWEEN O-RING AND HOUSING OR OPENINGS. ALSO, CHECK FOR ANY SEDIMENT OR MINERAL DEPOSITS BLOCKING OPENINGS. EXERCISE CAUTION NOT TO DAMAGE OR LOSE O-RING IN THE PROCESS. ALL OPENINGS ON FLOW CONTROL MUST BE FREE AND CLEAR OF ANY OBSTRUCTIONS FOR FLOW CONTROL TO FUNCTION PROPERLY. REINSTALL FLOW CONTROL. SEE DETAIL A FOR ORIENTATION.
- 4 INSERT BUFFER (INSERT) INTO EYE/FACE WASH HEAD NOTING ORIENTATION OF POST IN RELATIONSHIP TO ALIGNMENT GROOVE AS SHOWN ON DETAIL B.
- 5 REASSEMBLE EYE/FACE WASH HEAD, MAKING SURE THAT ALIGNMENT GROOVE ON EYE/FACE WASH HEAD LINES UP WITH ALIGNMENT TAB ON BASE.
- 6 REINSTALL SCREWS (QTY. 4) INTO THE EYE/FACE WASH ASSEMBLY. TIGHTEN SNUG TO ENSURE A WATERTIGHT SEAL. DO NOT OVER-TIGHTEN. TORQUE SPEC: 4 IN. LBS. MAX
- 7 REASSEMBLE EYE/FACE WASH ASSEMBLY ONTO ADAPTER (NOT SHOWN). ORIENT TAB TOWARDS THE BACK (AWAY FROM USER). DO NOT OVER-TIGHTEN.
- 8 PLACE DUST COVER (NOT SHOWN) ONTO EYE/FACE WASH.

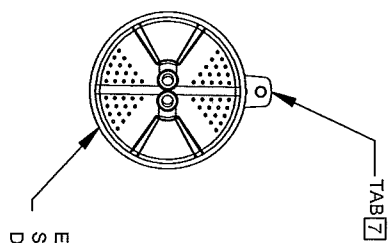

EYE/FACE WASH SHOWN WITHOUT DUST COVER [8]

NOTE ORIENTATION OF POSTS IN RELATIONSHIP TO ALIGNMENT GROOVE. POSTS MUST BE INSIDE OF RIBS (AS SHOWN).

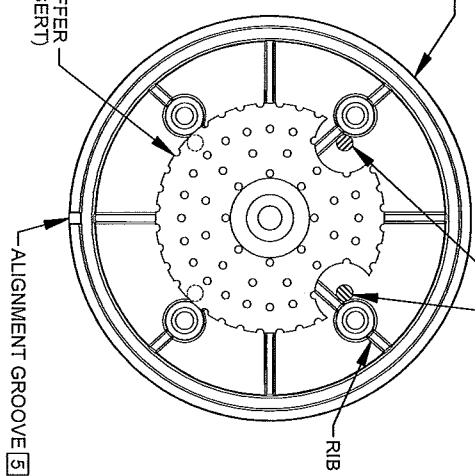

4 DETAIL B



1455 KLEPPE LANE
SPARKS, NEVADA 89431
(775) 389-4712 FAX (775) 389-7424
E-MAIL: HAWS@HAWS.CO.COM
WEBSITE: WWW.HAWS.CO.COM

EQ. NO. REVISED PER B.Y.	MODEL(S)	AX13 & AX13S
4898	AX13	
DATE	DATE	
J. VACK	J. VACK	
APPROVER	SCALE	1:8
	DRAWING TYPE	INSTALLATION
	SIZE	A 1 SHEET 6 OF 6
	PART NUMBER	0002080247 D
	DRAWING NO.	16283A
	REV	1