

APPVL INST CDM100 ATEX ENGLISH
EB-20023137
Revision: AA
Number of Pages: 13
Comments:

THIS COMPONENT MUST COMPLY WITH REGULATORY AGENCY REQUIREMENTS. NO CHANGES ARE ALLOWED WITHOUT PRIOR AUTHORIZATION FROM APPROVALS ENGINEERING.

Originator: RCS 10/05/12

Approved: RCS 10/05/12

Rev	ECN	Description	Approval	Date
AA	1049085	Release to Approvals	RCS	10/9/12





Equipment type **Meter type CDM100 *****(Z or F)*******

Manufactured and submitted for examination **Micro Motion, Inc.**

Address **Boulder, Co. 80301, USA**

Basis for examination **Annex II of Directive 94/9/EC**

Standard basis	EN 60079-0:2012	General requirements
	EN 60079-1:2007	Flameproof enclosure 'd'
	EN 60079-11:2012	Intrinsic safety 'i'
	EN 60079-31:2009	Dust Enclosure 't'

Code for type of protection **II 2G Ex ib IIC T1-T4/T6 Gb
II 2D Ex ib IIIC T*°C Db IP66/IP67
or
II 2G Ex d [ib] IIC T1-T6 Gb
II 2D Ex tb IIIC T*°C Db IP66/IP67**

EC Type Examination Certificate **BVS 13 ATEX E 033 X**



1) Subject and Type

Meter type CDM100*****

Instead of the *** letters and numerals will be inserted which characterize the following modifications:

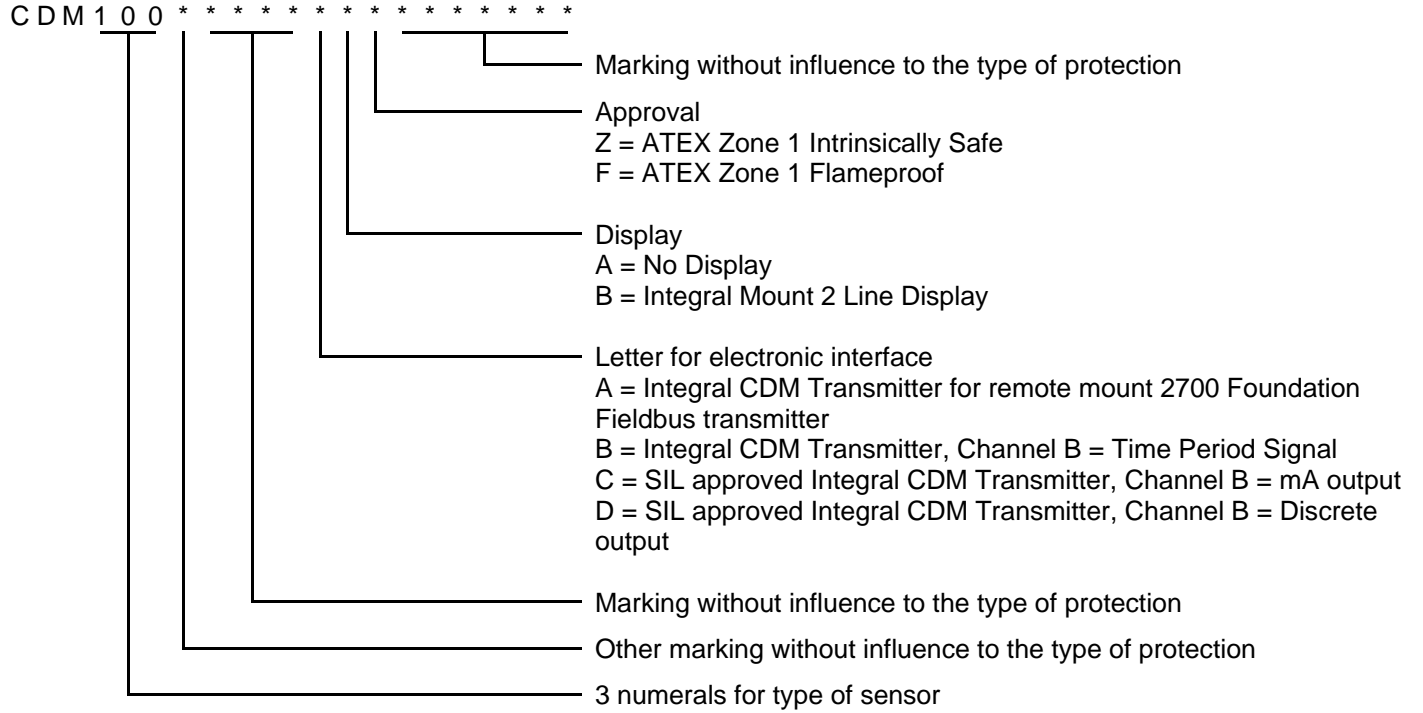

2) Description

The CDM100 flow sensor is used in combination with the CDM Density transmitter for Density measurement, forming a Liquid Density Meter.

The flow sensor, which consists of magnetically excited oscillating tubes, contains as electrical components coils, resistors, temperature sensors and terminals and connectors.

The CDM Density transmitter has its own certificate: BVS 13 ATEX E 003 X.

When used with an integral CDM Density transmitter, the variation gets the denomination type CDM100*****.



Meter type	
CDM100*****(B,C,D)AF*****	Ex d [ib] IIC T1-T6 Gb Ex tb IIIC T ¹ °C Db
CDM100*****(A,B,C,D)AZ*****	Ex ib IIC T1-T6 Gb Ex ib IIIC T ¹ °C Db
CDM100*****(B,C,D)BZ*****	Ex ib IIC T1-T4 Gb Ex ib IIIC T ¹ °C Db

¹⁾ Max. surface temperature T for dust for types CDM100***** see temperature graphs.

Modifications to the design which have impact on the electrical parameters are indicated by a Construction Identification Code (CIC). This code consists out of two digits, starting with an A and followed by a sequence number; for example A4. The CIC can be found on the approval label, see picture below:

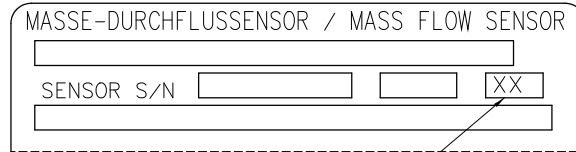

CONSTRUCTION IDENTIFICATION CODE (CIC)
(SHOWN APPROXIMATELY WHERE SHOWN)

3) Parameters

3.1. Type CDM100***** with integral CDM Density Transmitter

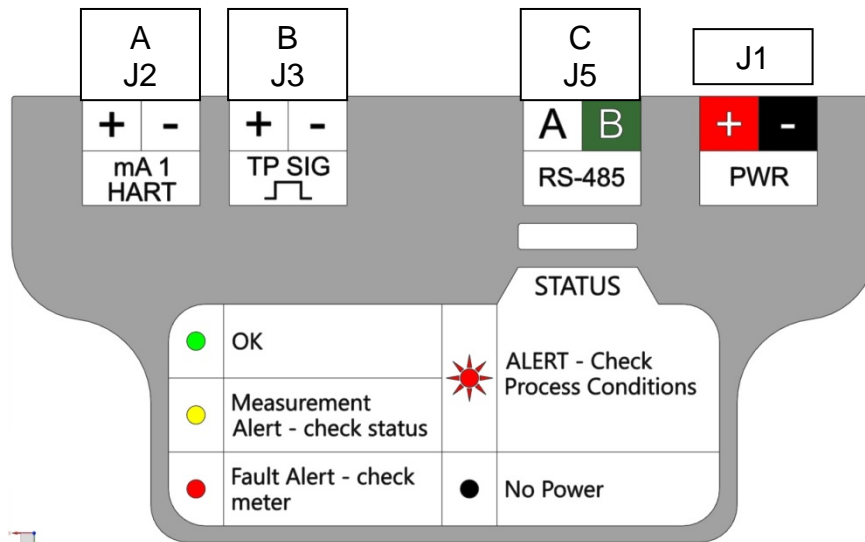

3.1.1. Electrical parameters CDM100*****(B,C,D)AF*****.

3.1.1.1 Non intrinsically safe main power supply (connector J1) :

Nominal voltage		DC	24V + 10 %
Maximum voltage	Um	AC/DC	250 V

3.1.1.2 Non intrinsically safe mA passive output with HART (Channel A, J2):

Nominal voltage		DC	24V +10%
Maximum voltage	Um	AC/DC	250 V

3.1.1.3 Non intrinsically safe configurable passive output; mA or DO or Time Period Signal Output (Channel B, J3)

Nominal voltage		DC	24V +10%
Maximum voltage	Um	AC/DC	250 V

3.1.1.4 Non intrinsically safe RS485 communication port (Channel C, J5)

Nominal voltage		DC	24V +10%
Maximum voltage	Um	AC/DC	250

3.1.1.5 Intrinsically Safe circuits [ib]: Drive-, Left Pick-Off-, Right Pick-Off- and Temperature element circuits.

3.1.2 Electrical parameters CDM100*****AAZ*****, connected to Remote 2700 transmitter DMT 01 ATEX E 082 X.

When connected to a Micro Motion 2700 Transmitter, connectors J2 and J3 are not utilized.

3.1.2.1 Intrinsically safe main power supply (connector J1) :

Level of protection Ex ib IIC or Ex ib IIIC

voltage	Ui	DC	17,22	V
current	Ii		484	mA
power	Pi		2,05	W
max. internal capacitance	Ci			negligible
max. internal inductance	Li			negligible

3.1.2.2 Intrinsically safe RS485 communication port (connector J5)

Level of protection Ex ib IIC or Ex ib IIIC

3.1.2.2.1 for connection of an intrinsically safe circuit (linear) with the following values

voltage	Ui	DC	17,22	V
current	Ii		484	mA
max. internal capacitance	Ci		1	nF
max. internal inductance	Li			negligible

3.1.2.2.2 Level of protection Ex ib IIC or Ex ib IIIC

voltage	Uo	DC	9,51	V
current (instantaneous)	Io		480	mA
current (steady state)	I		106	mA
power	Po		786	mW
internal resistance	Ri		19,8	Ω

for group IIC

max. external capacitance	Co		85	nF
max. external inductance	Lo		25	μH
max. external inductance/resistance ratio	Lo/Ro		31,1	μH/Ω

for group IIIC

max. external capacitance	Co		660	nF
max. external inductance	Lo		260	μH
max. external inductance/resistance ratio	Lo/Ro		124,4	μH/Ω

3.1.3. Electrical parameters CDM100*****(B,C,D)(A,B)Z*****

3.1.3.1 Intrinsically safe main power supply (connector J1) :

voltage	Ui	DC	30	V
current	Ii		484	mA
power	Pi		2,05	W
max. internal capacitance	Ci		0	µF
max. internal inductance	Li		0	H

3.1.3.2 Intrinsically safe mA output with HART (Channel A, J2):

voltage	Ui	DC	30	V
current	Ii		484	mA
power	Pi		2,05	W
max. internal capacitance	Ci		0	µF
max. internal inductance	Li		0	H

3.1.3.3 Intrinsically safe configurable output; mA or DO or Time Period Signal Output (Channel B, J3)

voltage	Ui	DC	30	V
current	Ii		484	mA
power	Pi		2,05	W
max. internal capacitance	Ci		0	µF
max. internal inductance	Li		0	H

3.1.3.4 Intrinsically safe RS485 communication port (Channel C, J5)

3.1.3.4.1 for connection of an intrinsically safe circuit (linear) with the following values

voltage	Ui	DC	18	V
current	Ii		100	mA
max. internal capacitance	Ci		1	nF
max. internal inductance	Li			negligible

Level of protection Ex ib IIC or Ex ib IIIC

voltage	Uo	DC	9,51	V
current (instantaneous)	Io		480	mA
current (steady state)	I		106	mA
power	Po		786	mW
internal resistance	Ri		19,8	Ω

for group IIC

max. external capacitance	Co		85	nF
max. external inductance	Lo		154	µH
max. external inductance/resistance ratio	Lo/Ro		31,1	µH/Ω

for group IIIC

max. external capacitance	Co		660	nF
max. external inductance	Lo		610	µH
max. external inductance/resistance ratio	Lo/Ro		124,4	µH/Ω

3.1.3.4.2 for connection of an intrinsically safe circuit (linear) with the following values

voltage	U _i	DC	17,22	V
current	I _i		484	mA
max. internal capacitance	C _i		1	nF
max. internal inductance	L _i			negligible

Level of protection Ex ib IIC or Ex ib IIIC

voltage	U _o	DC	9,51	V
current (instantaneous)	I _o		480	mA
current (steady state)	I		106	mA
power	P _o		786	mW
internal resistance	R _i		19,8	Ω

for group IIC

max. external capacitance	C _o		85	nF
max. external inductance	L _o		25	μH
max. external inductance/resistance ratio	L _o /R _o		31,1	μH/Ω

for group IIIC

max. external capacitance	C _o		660	nF
max. external inductance	L _o		260	μH
max. external inductance/resistance ratio	L _o /R _o		124,4	μH/Ω

3.1.4. Temperature class/ maximum surface temperature T.

The classification into a temperature class/determination of the maximum surface temperature T depends on the temperature of the medium taking into account the maximum operating temperature of the sensor and is shown in the following graphs:

3.1.4.1.

Meter type	
CDM100***** (B,C,D) AF*****	(IIC)

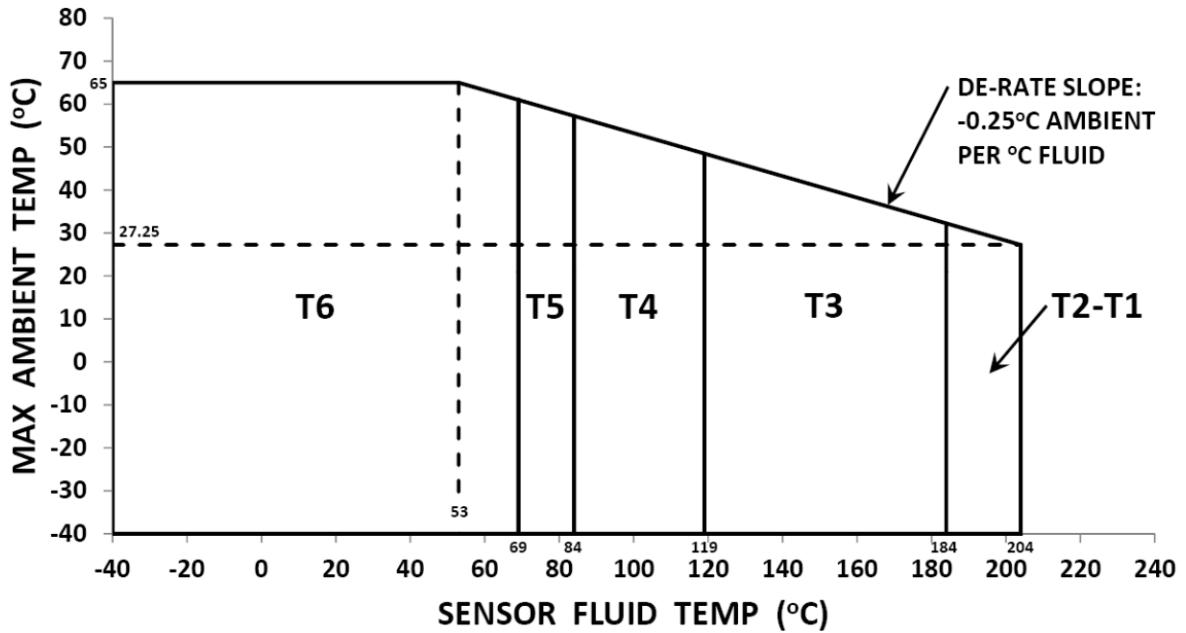

Note 1: Use the above graph to determine the temperature class for a given fluid and ambient temperature.

Note 2: The maximum surface temperature for dust is as follows: T6:T 80°C, T5:T 95°C, T4:T 130°C, T3:T 195°C, T2 to T1:T 215°C.

Ambient temperature range: Ta -40°C to +65°C.

3.1.4.2.

Meter type	
CDM100***** (A,B,C,D)AZ***** (IIC)	

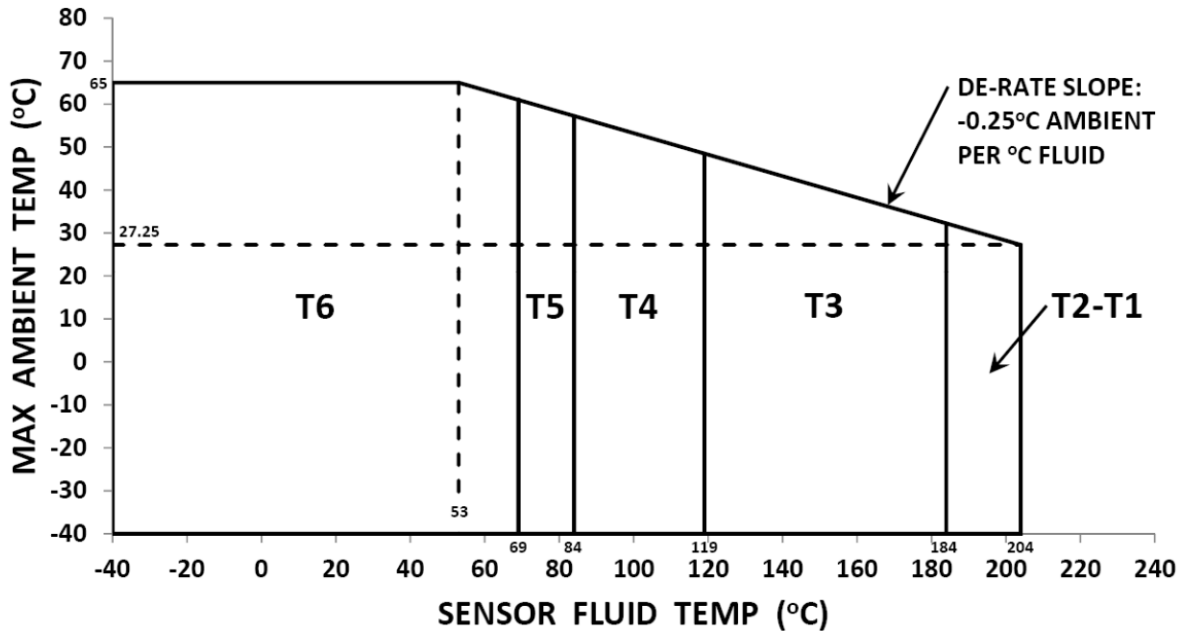

Note 1: Use the above graph to determine the temperature class for a given fluid and ambient temperature.

Note 2: The maximum surface temperature for dust is as follows: T6:T 80°C, T5:T 95°C, T4:T 130°C, T3:T 195°C, T2 to T1:T 215°C.

Ambient temperature range: Ta -40°C to +65°C.

3.1.4.3.

Meter type	
CDM100***** (B,C,D)BZ*****	(IIC)

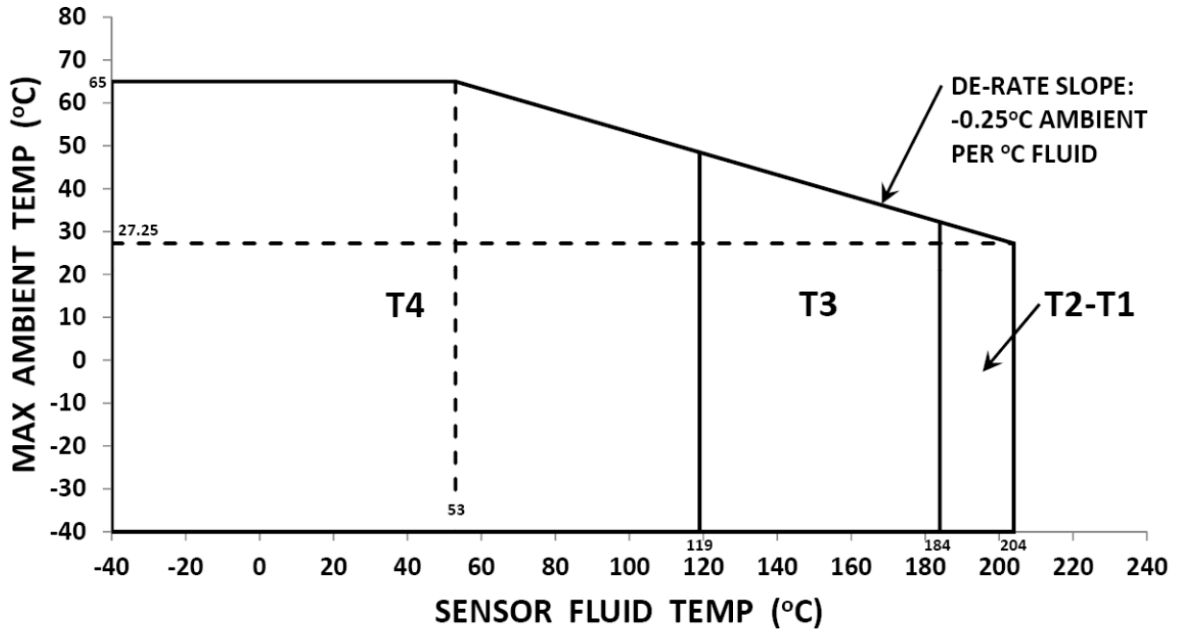

Note 1: Use the above graph to determine the temperature class for a given fluid and ambient temperature.

Note 2: The maximum surface temperature for dust is as follows: T4:T 130°C, T3:T 195°C, T2 to T1:T 215°C.

Ambient temperature range: Ta -40°C to +65°C.

4) Marking

The marking of the equipment shall include the following:

 II 2G with additional marking required by the standards mentioned in the following table:
II 2D

Type	Type of protection
CDM100*****(B,C,D)AF*****	Ex d [ib] IIC T1-T6 Gb Ex tb IIIC T ¹ °C Db IP66/IP67
CDM100*****(A,B,C,D)AZ*****	Ex ib IIC T1-T6 Gb Ex ib IIIC T ¹ °C Db IP66/IP67
CDM100*****(B,C,D)BZ*****	Ex ib IIC T1-T4 Gb Ex ib IIIC T ¹ °C Db IP66/IP67

¹⁾ Maximum surface temperature T for dust, see temperature graphs

Ambient temperature range -40°C up to 65°C

5) Special conditions for safe use / Installation instructions

- 5.1 The permissible ambient temperature range is -40°C to +65°C. The use of the meter at an ambient temperature lower than -20°C is only admissible, if the cables are suitable and the cable entries resp. blanking plugs are certified for that temperature and use.
- 5.2 For use in explosive atmosphere caused by combustible dust, suitable cables and for that purpose certified cable entries resp. blanking plugs shall be used.
- 5.3 If certified conduit entries are used for the connection of the transmitter enclosure, the associated stopping boxes shall be installed immediately at the enclosure.
- 5.4 User Interface option is not allowed with model CDM100*****(A,B,C,D)AF*****; only with model CDM100*****(B,C,D)BZ*****.