



**OMNTEC**  
Advanced Tank Monitoring & Leak Detection



1. Open the camera app
2. Focus the camera on the QR code by gently tapping the code
3. Follow the instructions on the screen to view PDF file

# OEL8000III-B

## INSTALLATION MANUAL

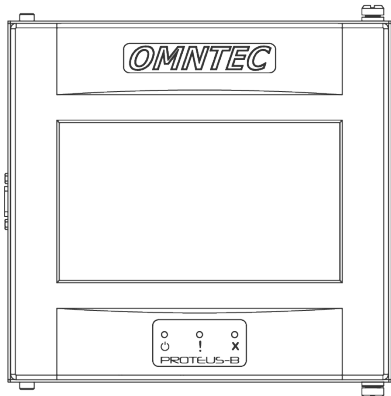

## PROTEUS® Series TANK GAUGING SYSTEM

Revision 1.1

Document No. DI00003 rev1.1

OMNTEC Mfg., Inc. has been certified  
by DQS Inc. to ISO 9001:2015

## PROPRIETARY INFORMATION NOTICE

This document contains information and material developed by OMNTEC Mfg., Inc. All rights are reserved. No part of this document may be reproduced, transmitted, processed or recorded by any means or form, electronic, mechanical, photographic or otherwise, without the express written consent of OMNTEC Mfg., Inc. Printed in the United States of America

© Copyright 2012 OMNTEC Mfg., Inc

## NOTICE

Use of unauthorized parts in the OEL8000III-B system or modification to any parts of the system will nullify U.L. listing and our warranty. OMNTEC Mfg., Inc. will not be responsible for any claims arising from the performance of modified units.

If you have any questions, please contact OMNTEC Mfg., Inc. at (631) 981-2001.

## WARRANTY

The seller, OMNTEC® Mfg., Inc. warrants to buyer that product is free of defects when properly installed and maintained by user. Warranty period is one year from the date of installation or 15 months from the date of shipment from factory, whichever occurs first. The seller's sole obligation is to repair or replace parts found to be defective upon evaluation by OMNTEC. Parts can be returned for evaluation by requesting an RMA (Return Material Authorization) from OMNTEC. The liability of the seller shall not exceed the price paid for components found to be defective. The above warranty is exclusive of all other warranties whether implied or expressed. Seller assumes no obligation for special or indirect damages incurred by user.

OMNTEC warranty for custom probes, custom controllers, add-ons, spare or replacement parts is for 90 days from date of shipment. All items must be properly installed for warranty to be valid. Any items found to have factory defects after evaluation by OMNTEC through return material authorization process, will be repaired or replaced. The liability of seller shall not exceed price paid for item found to be defective by factory evaluation. The above warranty is exclusive of all other warranties whether implied or expressed. OMNTEC assumes no responsibility or obligation for special or indirect damages incurred by user.

## READ THIS FIRST!

The OEL8000III-B has been designed using intrinsically-safe principles and is Underwriters Laboratories (U.L.) listed and CUL listed for petroleum storage tanks. It is approved for Class I, Groups C and D or Class I, Zone 0, Group IIB Hazardous locations when connected in accordance with control drawing number DOC00001.

USL, CNL Associated Apparatus for use in Non-hazardous locations; [AEx ia Ga] IIB and [Ex ia Ga] IIB

The OEL8000III-B Proteus series models B4, and B8 provides intrinsically-safe outputs for use in Class I, Division 1, Groups C and D, and Class I, Zone 0 Group IIB Hazardous Locations when installed in accordance with manufacturer's control drawing no. DOC00001.



## WARNING

Do not attempt to make any other adjustments no matter how simple they may appear.

All work must be performed only by authorized personnel who are qualified using intrinsically-safe design principles (NEC procedures) and are thoroughly familiar with the OEL8000III-B Installation Manual. At a minimum, it is the installer's responsibility to be familiar with and to comply with intrinsic design principles as defined in the National Electrical Code. It is also the installer's responsibility to be familiar with and to comply with applicable local codes.

Improper wiring or installation can compromise the intrinsically-safe design of the system and create an electric shock or explosion hazard.

**YOU CAN CAUSE DEATH OR SERIOUS PERSONAL INJURY TO YOURSELF AND OTHERS AND EXTENSIVE PROPERTY DAMAGE.**



## WARNING

Observe the following rules. Failure to do so will create an electric shock or explosion hazard that can result in death, personal injury, or property damage.

1. Do not permit unauthorized personnel to install or service the equipment.
2. Power to the controller must be removed before installing or servicing the equipment.

## IMPORTANT SENSOR INFORMATION

\*\*\*

**ONLY INSTALL BX SERIES SENSORS WITH THE OEL8000III-B**

\*\*\*

*Please verify sensors have been installed according to the Installation Instructions and Programming Worksheet provided before calling technical support.*

### **Don't VOID Your Warranty!**

Warranty will be void if OMNTEC EC-2 (Belden #8761) cable is not used with MTG Series probes.

## READ ME!

### **Earth Ground Warning**

The earth ground terminal must be connected to maintain intrinsic safety as well as UL and NEC.

## READ ME!

### **Use Preformed Knockouts**

If preformed knockouts are not used, warranty will be void.

### **Do Not Drill on Enclosure**

**Please verify sensors have been installed according to the Installation Instructions and Programming Worksheet provided before calling technical support.**

# Table of Contents

---

1. Overview .....	6
1.1. System Description.....	6
1.1.1. System Specifications.....	6
1.2. List of Required Documents: .....	6
1.3. Safety.....	7
1.4. Unpacking, Inspection and Damage Claims.....	7
1.5. Returns .....	8
1.6. Electrical Wiring .....	8
1.6.1. Wires and Cables .....	8
1.6.2. Conduits.....	9
2. Equipment.....	10
2.1. Controller .....	10
2.1.1. Preparation .....	10
2.1.2. BX Series Sensor Worksheet.....	11
2.2. Controller Installation.....	11
2.2.1. Mounting the Controller .....	11
2.2.2. Wiring, Controller Knockout Designations, and Mounting Dimensions .....	11
2.2.3. Junction Boxes .....	13
2.2.4. EYS Seal-Off Fitting.....	13
2.2.5. Inside the OEL8000III-B (including probe and sensor wiring) .....	13
2.2.6. Powering the OEL8000III-B via Main Panel or Sub Panel .....	16
2.2.7. AC Power Line .....	17
2.2.8. Telephone Connections at the Controller .....	17
2.2.9. AC Power Connections at the Controller.....	17
2.2.10. Main Panel and Sub-Panel Grounding .....	17
2.3. Remote Communications .....	18
3. Markings and Certifications.....	19
APPENDIX A - OEL8000IIIB4 Sensor Installation Worksheet .....	20

# 1. Overview

---

## 1.1. System Description

The OMNTEC OEL8000III-B is a comprehensive tank gauging and leak detection system designed to bring tank owners into compliance with EPA regulations. It provides real-time simultaneous monitoring of tanks, identifying water and product levels as well as leaks in single or double wall steel and fiberglass tank systems. Bright Eye Series leak and level detection sensors can be added for monitoring interstitial spaces, piping sumps, double wall piping, dispenser pans, dikes, and observation wells. Alarm conditions are identified by the controller. The OEL8000III-B also provides a user-friendly inventory management system for identifying usage and alerting the customer inventory.

The system consists of a controller that is wall-mounted in a non-hazardous location and a combination of probes and sensors for monitoring water and product levels, temperatures, and leaks. System programming and status reporting are achieved via the controller. Remote communication capability can be provided by an optional external modem and RS-232 port. Easy to read status and inventory data is provided on the controller's optional LCD display. The OMNTEC OEL8000III-B is an intrinsically-safe system and is Underwriters Laboratories listed for petroleum storage tanks.



### 1.1.1. System Specifications

SPECIFICATIONS	
<b>Input Power:</b>	100-240 VAC +/- 10% 50/60 Hz 60 watts
<b>Voltage to Sensors:</b>	12 VDC
<b>Voltage to Probes:</b>	28 VDC
<b>Display:</b> <b>Audible alarm:</b> <b>System status:</b>	Color 7-inch graphic display with touch-screen (optional) 85 dB piezoelectric horn 3 LED's (OK, fault, alarm)
<b>Operating Temperature:</b>	20 to 140° F (-7° to 60° C)
<b>Approvals:</b>	UL-listed, CUL-listed, ATEX, IECEx

## 1.2. List of Required Documents:

- a) DOC00001.pdf - **PROTEUS Entity System Control Drawing**

### 1.3. Safety

To install or service any component of the OEL800III-B system, the individual must be qualified using intrinsically-safe design principles (NEC practices) and must be familiar with the specifications and procedures described within this manual. It is the responsibility of the installer and operator to be familiar with and to comply with all codes and regulations. Before you begin, read *Figure 5 - Applying Power*. When you have finished, return to the beginning, and read the entire manual. The following are some safety tips to be used during installation and servicing:

- **Do not** perform any installation or service procedures if you are not qualified to work with intrinsically-safe systems.
- **Do not** perform any installation or service procedures if you are not familiar with the National Electrical Code and all other federal, state, and local codes and regulations pertaining to this installation.
- **Do not** perform any installation or service procedures until you have read through and understand this **entire** manual.
- **Do not** install the controller in a hazardous location.
- **Do not drill** through enclosure
- **Do not** mount outdoors without ENC-4X weatherproof enclosure (*heater & thermostat may be required*)
- **Only** sensors and probes are to be installed within hazardous locations.
- **Do not** substitute components. The intrinsic safety design can become compromised creating an explosion hazard. It will also void the warranty.
- **Do not** apply power to the controller until all the other installation and wiring have been completed and inspected. Read *Figure 5 - Applying Power*. Applying power to the controller and programming the controller are the **final** steps in the installation process.
- **Always turn off power** to the controller before servicing.
- Take all safety precautions to avoid accidents.
- Keep work area clean.
- Block off work area when working on tanks and hazardous locations to prevent vehicles and pedestrians from entering the area.
- Use proper fire prevention measures to keep all sparks, flames, and other ignition devices away from the hazardous area.

### 1.4. Unpacking, Inspection and Damage Claims

Unpack and thoroughly inspect all equipment before accepting receipt from carrier. If you detect or suspect any damage or loss, do the following:

1. Write a detailed description of the damage or loss on the front of the bill of lading and sign it.
2. Have the carrier's agent sign the bill of lading.
3. Immediately notify the carrier by phone and follow up in writing within 48 hours.

The buyer assumes all risk for damage or loss of merchandise incurred during shipping and is responsible for filing and settling any claims. If you report your loss to OMNTEC Mfg., Inc. however, we will attempt to assist you with your claim.

## 1.5. Returns

You must obtain a Return Material Authorization (RMA) from OMNTEC Mfg. before returning shipments. Shipments that are returned without such authorization will be rejected. All freight charges for returned materials must be prepaid.

**NOTE: RMA # MUST APPEAR ON SHIPPING LABEL**

## 1.6. Electrical Wiring

**Do not apply power to the controller until you have read and complied with *Figure 5 - Applying Power*. All electrical work should be performed by qualified personnel only and in accordance with the National Electrical Code and all federal, state, and local codes and regulations as pertains to this installation.**



### **WARNING**

Failure to comply can create an electric shock or explosion hazard causing death, personal injury, or property damage.



### **CAUTION**

Failure to make electrical splices, conduits, and junction boxes water-tight can result in system failure due to wet wires.

### 1.6.1. Wires and Cables

Observe the following when selecting and installing wires and cables:

- Run a single 4-conductor cable for each sensor bus (*see Control Drawing Document No. DOC00001, Model B4*).
- Up to 16 sensors may be connected to B4 model only.
- Two or more probes may not be combined into a single cable (see Control Drawing Document No. DOC00001 Model B-4 and B-8)
- Probes and sensors may not be combined into a single cable [*see Figure 3 - Inside PROTEUS-B4 (with Probe and Sensor Wiring) and Figure 4 - Inside PROTEUS-B8 (with Probe wiring)*].
- Splice sensor wires using the SK-4 connector sealing kit
- Splice probe wires using the SK-4 connector sealing kit
- Probe cables and sensor cables must be completely enclosed in conduit from the junction box to the console (contact factory for direct-burial applications)
- Probe and sensor cables may share the same conduit
- Probe and sensor cables must be run in conduits that are separate from other wiring.



- All wiring must enter the controller through the designated preformed knockouts (see Figure 2 - Panel Knockouts for Conduit Circuitry and Mounting Dimensions).



## WARNING

Failure to comply can create an electric shock or explosion hazard causing death, personal injury, or property damage.

Note: Direct-burial wiring is available. Contact manufacturer.

### 1.6.2. Conduits

Base the location and number of conduits required for the installation on the number and diameter of the probe and sensor cables. Use a junction box inside the building to combine the cables as described below. **Observe the applicable codes pertaining to which cables may or may not be combined into a single conduit.**

**You must have separate conduits as follows:**

- 120 VAC Power cables must be combined in a separate (isolated) conduit.
- MTG Probe and sensor cables may share a separate (isolated) conduit.

**Use and select the proper conduit types and sizes in accordance with applicable codes. Even in situations where they are not required by code, it is recommended that they be used to protect wiring.**

*Note: Make certain that all conduits and junction boxes are dry and watertight. Wet wires can result in the faulty operation of the system.*

**Observe the following when selecting and installing conduit:**

- Determine the conduit size based on the number and size of cables it will carry.
- Plan the conduit installation so that the junction box in the manway will not become submerged in water after a heavy rain.
- Rigid metal conduit, 3/4-inch or larger (use reducer coupling, do not drill into box) is recommended between the controller and the tank area.
- Do not combine probe and sensor cables with other wires in the same conduit.
- Install the conduit seal fittings in accordance with NFPA 70 (National Electrical Code) and NFPA 30 (Automotive and Marine Station Code).
- All wires should enter the controller via a conduit.



## WARNING

Failure to comply can create an electric shock or explosion hazard causing death, personal injury, or property damage.

## 2. Equipment

---

### 2.1. Controller

The OEL8000III-B controller is mounted in a non-hazardous area and requires 100-240 VAC, 50/60 Hz, 60 watts. It monitors all probes and sensors providing status and alarm information on its optional LCD 7" color touch-screen display. The OEL8000III-B has the capability of communicating alarm conditions and inventory status to a remote terminal or central station using an optional external modem or RS-232 output.

Figure 1 – OEL8000III-B Front Panel

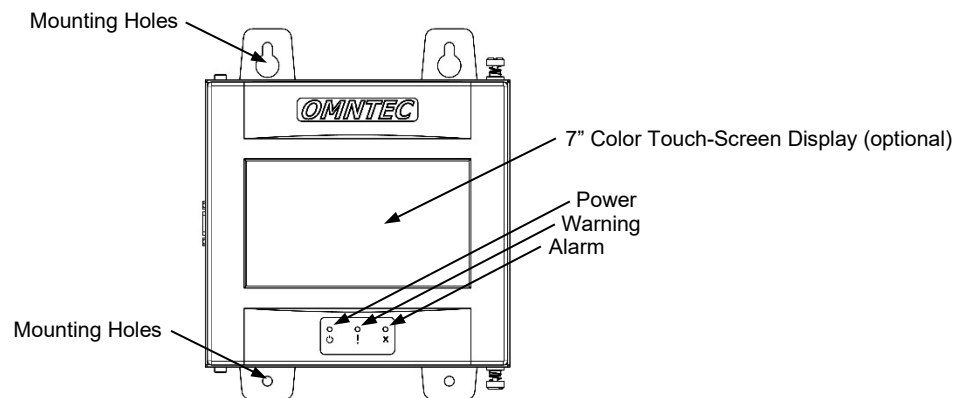

#### 2.1.1. Preparation

Perform the following steps before beginning construction or installation:

1. Inspect all the parts for shipping damage.
2. Review *Figure 5 - Applying Power*
3. Determine all the conduit paths, probe and sensor installation locations, and controller mounting locations.
4. Review the programming instructions (*refer to document no. DOC00007*) and prepare the required data in advance of programming the controller.
5. Review the National Electrical Code and the federal, state, and local codes applicable to this installation to ensure compliance.

**Do not apply power to the controller until all installations and wiring have been completed.**



Failure to comply can create an electric shock or explosion hazard causing death, personal injury, or property damage.

### 2.1.2. BX Series Sensor Worksheet

If your system is using BX Series Sensors, a sensor worksheet **must** be completed. The information on this worksheet will be required when programming your system. (Refer to *Appendix A - OEL8000IIIB4 Sensor Installation Worksheet*)

Note: For factory-programmed systems, this worksheet was previously completed and provided to customer.

## 2.2. Controller Installation

Observe the following installation requirements:

- Locate the controller indoors, **in a non-hazardous**, protected location.
- Locate controller at eye level, where it is easily accessible, and its alarms will be heard.
- Locate the controller in a dry area (avoid sweating or leaking pipes and areas where rain can enter).
- Locate the controller in areas where temperatures will stay between 20°F and 140°F (-7°C and 60°C).
- It is recommended that the controller is mounted on an inside wall that is close to where the conduits will be entering the building to ease installation.
- Use proper anchor bolts for wall type.
- Allow 6" clearance on the top and sides of the controller for air circulation.
- Make certain that there is sufficient clearance for opening the controller door.
- Allow for sufficient clearance around the controller for conduit access. All conduits will enter the controller through the designated preformed knockouts. (see *Figure 2 - Panel Knockouts for Conduit Circuitry and Mounting Dimensions*)
- Avoid installing in corners.
- Do not install behind doors that may cause damage to the unit.

### 2.2.1. Mounting the Controller

The controller is mounted on the wall using the mounting flange. Do not attempt to remove the motherboard or any internal components (printed circuit board) in order to mount the panel from the inside. (Refer to *Figure 2 - Panel Knockouts for Conduit Circuitry and Mounting Dimensions*)

1. Place the panel against the wall and use it as a template.
2. Install proper anchors and bolts for wall type.

**Note: Drilling any holes in the controller will void warranty.**

### 2.2.2. Wiring, Controller Knockout Designations, and Mounting Dimensions

All wiring must be performed in accordance with Control Drawing No. DOC00001. Before making any connections inside the panel, refer to *Control Drawing Document No. DOC00001 Model B-4 and B-8 supplied with equipment*.

All wiring enters the controller via conduit through the designated preformed knockouts as shown in *Figure 2 - Panel Knockouts for Conduit Circuitry and Mounting Dimensions*. You must adhere to the following wiring requirements, failure to do so will void warranty:

- AC Power can enter the controller through K1 or K5. **AC input must come in dressed tight and not contact the IS cover.**
- K2, K3, K4 and K6 are reserved for the sensor and probe cables only.
- External CAN wires enter the controller through K1 or K5, whichever is not used by AC power.
- The RS-232 port is located at K7 on the left side of the panel.



Failure to comply will defeat the intrinsically-safe design of the system and will create an explosion hazard. Consult the National Electrical Code pertaining to voltage and wire specification requirements for merging wires into the same conduit.

**Figure 2 - Panel Knockouts for Conduit Circuitry and Mounting Dimensions**

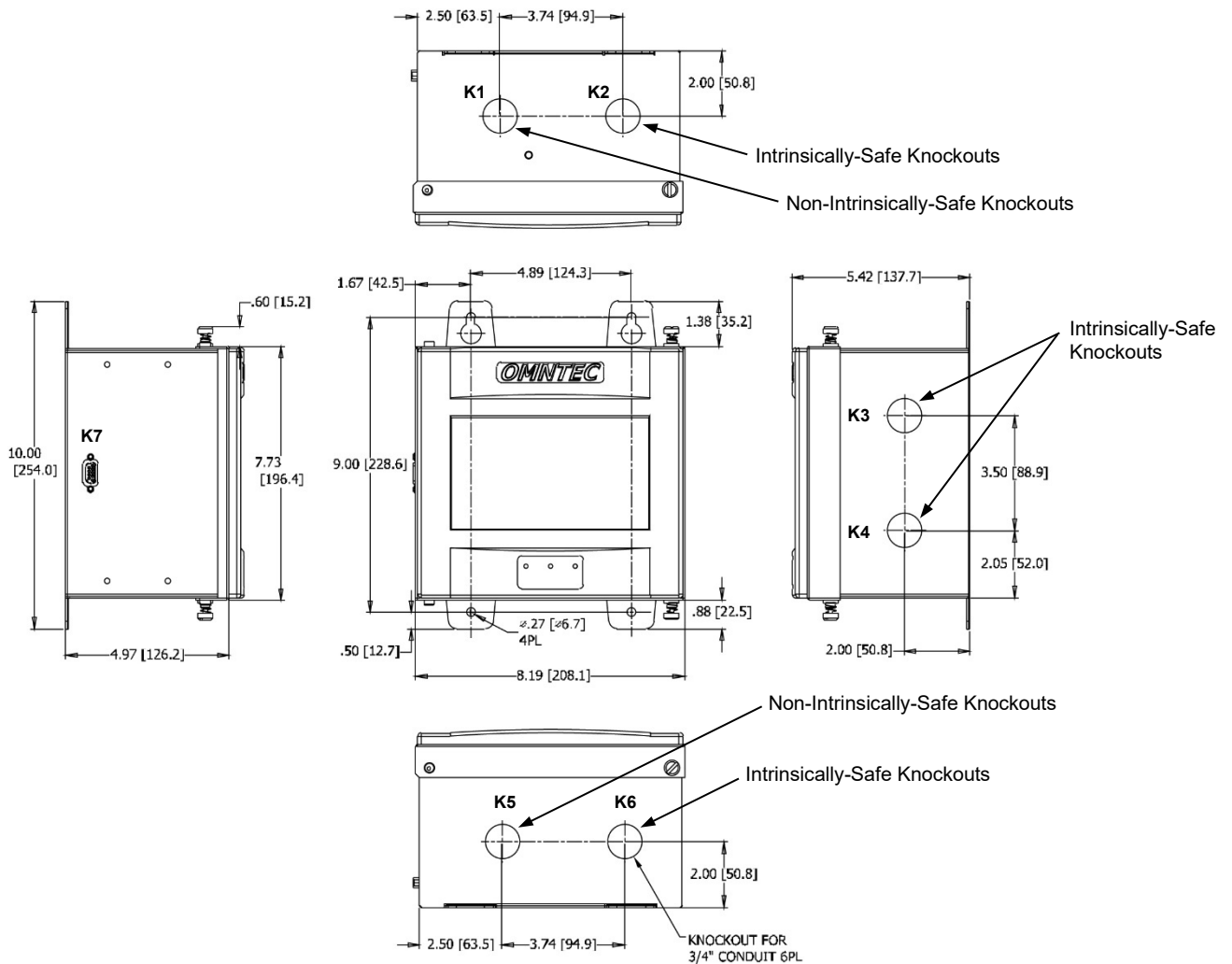

### 2.2.3. Junction Boxes

Mount waterproof junction boxes in manways to provide access to probe and sensor connections after installation.

*Note: Make certain that all conduits and junction boxes are dry and watertight. Wet wires can result in the faulty operation of the system.*

Observe the following when selecting and installing junction boxes:

- Use waterproof junction boxes inside each manway.
- Junction box size should meet code requirements.
- Mount the junction box in each manway so that it will not become submerged in water after a heavy rain.

### 2.2.4. EYS Seal-Off Fitting

Consult National Electrical Code and other applicable codes for EYS installation. Make installations as follows:

- Install EYS seal-off fittings in accordance with applicable codes.
- Prior to applying appropriate sealing compound in all EYS, be sure entire system is functioning properly

### 2.2.5. Inside the OEL8000III-B (including probe and sensor wiring)

Input Specifications	Probe Inputs (B4/B8)	Sensor Inputs (B4/B8)
Number of Inputs:	4/8	16/0
Maximum Output Voltage:	$U_o = 29.4V$	$U_o = 14.28V$
Maximum Output Current:	$I_o = 65mA$	$I_o = 352mA$
Maximum External Capacitance:	$C_o = 0.587\mu F$	$C_o = 4.28\mu F$
Maximum External Inductance:	$L_o = 33.6\text{ mH}$	$L_o = 1.15\text{mH}$
Maximum Output Power:	$P_o = 478\text{mW}$	$P_o = 847\text{mW}$

#### Probe and Sensor Wiring

- Splice sensor wires using the SK-4 connector sealing kit
- Splice probe wires using the SK-4 connector sealing kit
- Probe cables and sensor cables must be completely enclosed in conduit from the junction box to the console (contact factory for direct-burial applications)
- Probe and sensor cables may share the same conduit

MODEL	SENSORS	PROBES
B4	Up to 16	Up to 4
B8	None	Up to 8

Figure 3 - Inside PROTEUS-B4 (with Probe and Sensor Wiring)

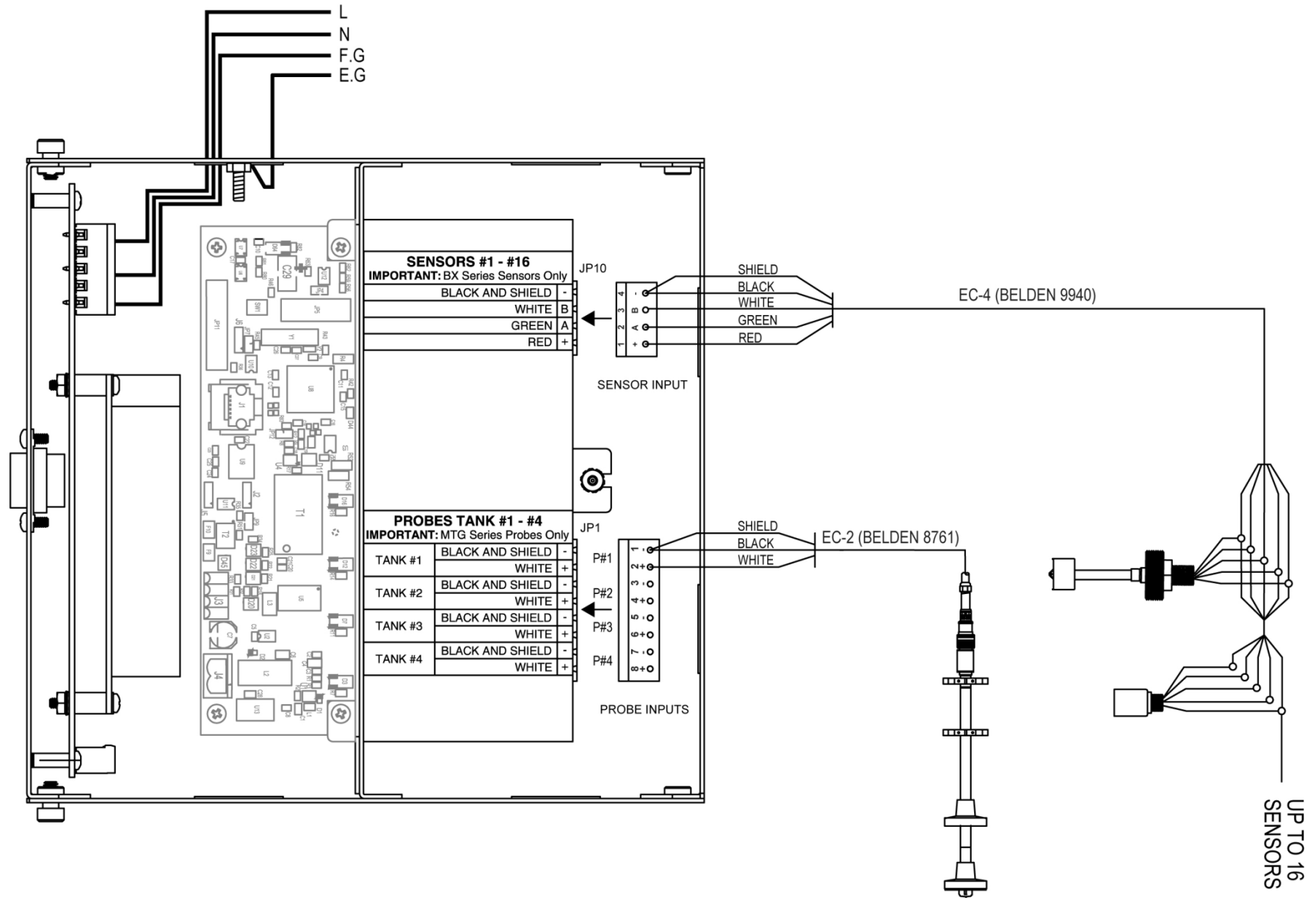
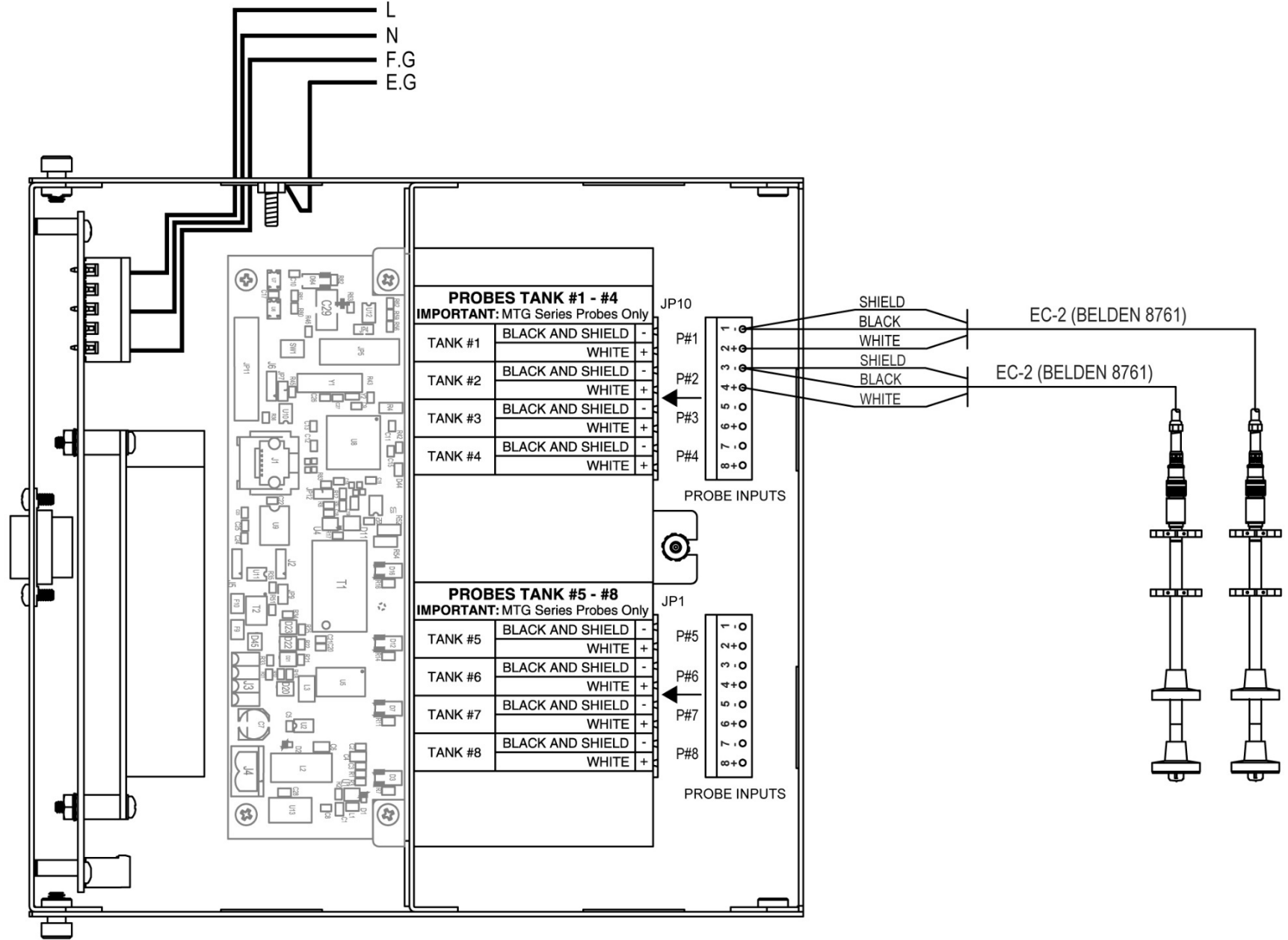
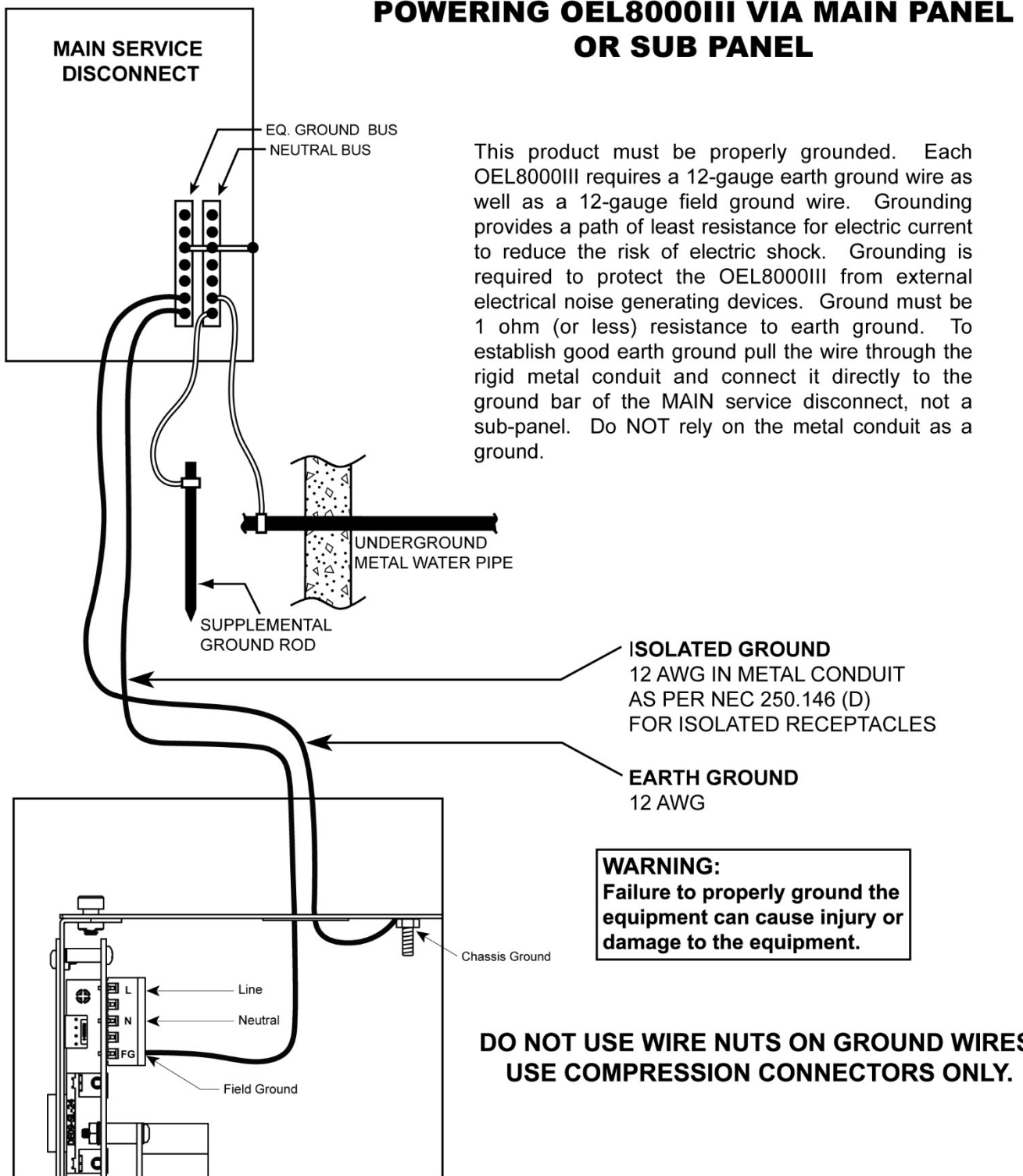

Figure 4 - Inside PROTEUS-B8 (with Probe wiring)



2.2.6. Powering the OEL8000III-B via Main Panel or Sub Panel

Figure 5 - Applying Power





### 2.2.7. AC Power Line

The AC power line will run from the control panel directly to a 15-amp circuit breaker within a circuit breaker panel via conduit. **Select wire in accordance with code for this installation.**

**Note: To maintain intrinsically-safe design principles and UL requirements, field ground and earth ground must be installed properly (see Figure 5 - Applying Power).**

### 2.2.8. Telephone Connections at the Controller

The OEL8000III can be used with a line sharing device; consult factory for details. Do not use any extensions or services such as *Call Waiting*. These features can interrupt communications.

Bring the external telephone modem cable via conduit to DB9 connector on left side of controller.

All other remote communications devices (i.e., RS-232) should be connected to the OEL8000III using a 9-pin male connector. The remote communications ports are located on the left-side panel of the controller. See section 2.3 for details.

### 2.2.9. AC Power Connections at the Controller

The controller requires its own dedicated circuit. Input power must be 100-240 VAC, 50/60 Hz. Bring the AC power line into the panel via the conduit knockout K1 or K5 as shown in Figure 2 - Panel Knockouts for Conduit Circuitry and Mounting Dimensions. Make the following connections inside the controller.

1. Connect the line voltage wire to the **L** terminal.
2. Connect the neutral wire to the **N** terminal.
3. Connect the field ground wire to the **F.G.** terminal.
4. Connect the earth ground wire to the chassis ground lug.

**The cover must be able to open and close freely.**

Bring the other end of the AC power line into the circuit breaker panel and connect to a 15-amp circuit breaker.



Electric Shock Hazard. Make certain that the circuit breaker is in the OFF position. Avoid touching other lines. Failure to comply can result in an electric shock causing death or personal injury.

### 2.2.10. Main Panel and Sub-Panel Grounding

Pull the wire through the rigid metal conduit and connect it directly to the ground bar of the **main** electrical service panel, not a sub-panel. Do **not** rely on the metal conduit as ground. See Figure 5 – Applying Power.

## 2.3. Remote Communications

Access to the system by computer is achieved by adding either an external MDR-3 fax/modem or utilizing the system's RS-232 output\*. This allows for real-time monitoring of the system and downloading of status information to any remote location. A user-friendly software program (OMNTEC PC) or serial communication documents are available; call OMNTEC Mfg., Inc. for further information.

**Figure 6 - External Connection**

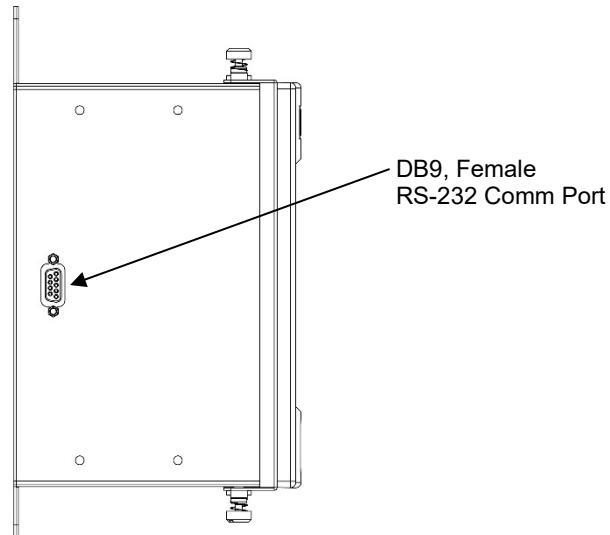

**RS-232 pinout:**

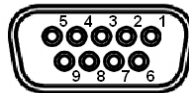

Pin #	Function
Pin 2	Transmit Data
Pin 3	Receive Data
Pin 5	Signal Ground

\*MODBUS RTU communication capable

**For further information, please refer to this document:**

*Proteus-B/K/X Modbus communications*

File name: DOC00005

### 3. Markings and Certifications

---

MODEL

**PROTEUS® B/K/X**

TANK GAUGING & LEAK DETECTION  
CONTROLLER

SERIAL NUMBER \_\_\_\_\_

---

Tank Monitoring Equipment  
(Associated Apparatus Appareillage Connexe)



IECEX UL 13.0057  
[Ex ia Ga] IIB

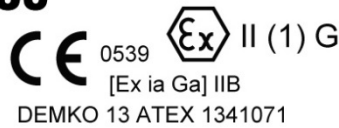

Associated Apparatus; non-hazardous locations; [AEx ia Ga] IIB; [Ex ia Ga] IIB provides intrinsically safe outputs for use in Class I, Div.1, Groups C and D or Class I Zone 0, Group IIB hazardous locations when connected in accordance with control drawing number DOC00001.

Warning: substitution of components may impair intrinsic safety.

Advertissement: la substitution de composants peut compromettre la sécurité intrinsèque.

---

#### ELECTRICAL RATINGS

INPUT: 100-240 VAC, 60 W max, 47-63 Hz

---

#### ENTITY PARAMETERS

SENSOR INPUTS:  $U_o = 14.28V$ ,  $I_o = 352mA$ ,  $C_o = 4.28\mu F$ ,  
 $L_o = 1.15mH$ ,  $P_o = 847mW$

PROBE INPUTS:  $U_o = 29.4V$ ,  $I_o = 65mA$ ,  
 $C_o = 0.587\mu F$ ,  $L_o = 33.6 mH$ ,  $P_o = 478mW$

$U_m = 250V$

$0^\circ C = T_{amb} = 60^\circ C$

UL Type 1 Enclosure

---

OMNTEC Mfg., Inc.  
Ronkonkoma, New York 11779  
Made in the U.S.A

#### Certifications and conditions of use:

The OEL8000III-B complies with the following standards:

- IEC 60079-0:2017
- IEC 60079-11:2011
- EN 60079-0:2018
- EN 60079-11:2012
- UL60079-0 ED.7
- UL60079-11 ED.6
- UL913 ED.7
- CAN/CSA C22.2 No. 152.92 (R2012)
- CAN/CSA C22.2 60079-0:15
- CAN/CSA E60079-11:14

• The associated apparatus must be connected to an intrinsically-safe apparatus, following the conditions and entity parameters listed on the control drawing.

• For installations in which both the  $C_i$  and  $L_i$  of the intrinsically-safe apparatus exceeds 1% of the  $C_o$  and  $L_o$  parameters of the associated apparatus (excluding the cable), then 50% of  $C_o$  and  $L_o$  parameters are applicable and shall not be exceeded. The reduced capacitance of the external circuit (including cable) shall not be greater than  $1\mu F$  for Groups I, IIA and IIB and  $600nF$  for Group IIC.

# APPENDIX A

---

## OEL8000IIIB4 SENSOR INSTALLATION WORKSHEET

# PROTEUS® OEL8000IIIB4 SENSOR INSTALLATION WORKSHEET



This form **MUST** be filled out prior to sensor installation

**\*\*\* 16 SENSOR MAXIMUM \*\*\***

**Instructions:**

1. Prior to installation you must know each **part number** and it's corresponding **serial number**
2. During installation you must document the **location** of each sensor
3. During programming you must document the sensor # assigned by the OEL8000III in coordination with it's serial #

SENSOR P/N	SERIAL #	LOCATION*	TANK #	SENSOR #
EXAMPLE: BX-PDS	200999999	PIPING SUMP	1	<<assigned by OEL8000III>>

Site Information:

Name: \_\_\_\_\_

Address: \_\_\_\_\_

City: \_\_\_\_\_

State: \_\_\_\_\_ Zip \_\_\_\_\_

Phone: \_\_\_\_\_

Contact: \_\_\_\_\_

Installed by: \_\_\_\_\_

Company: \_\_\_\_\_

Address: \_\_\_\_\_

City: \_\_\_\_\_

State: \_\_\_\_\_ Zip \_\_\_\_\_

Phone: \_\_\_\_\_

Name: \_\_\_\_\_

*I hereby certify that this system has been installed in accordance with the specifications set forth in the OMNTEC installation manual. Failure to follow OMNTEC procedures will void warranty.*

Signature of installer: \_\_\_\_\_

**\*MAXIMUM 20 CHARACTERS for manual labels**