



VAREC 221 SERIES EMERGENCY PRESSURE RELIEF MANWAY COVERS

The 221 Series is designed to provide emergency venting of low pressure storage tanks and vessels

221P



221PV

FEATURES

- Available in emergency pressure only and emergency pressure and vacuum relief models.
- Cast metal cover provides added strength and extended life.
- Hinged cover provides a fixed pivot point, ensures proper reseating and added safety.
- Cover cannot separate from the base.
- Easily lifted open to provide a large, unobstructed passage for easy tank access.
- 221PV incorporates a spring loaded vacuum relief valve integral to the cover assembly.
- Weather hood and screen provided for protection.
- Non-metallic seat insert on the pallet minimizes leakage.
- Durable reinforced fabric diaphragm type pressure side seating surface backed by compressible, cellular non-metallic pads for added cushion and reduced leakage.
- Optional materials available to suit most chemical applications.

GENERAL APPLICATION

221 Series manways protect tanks against costly rupture or implosion. The 221P provides emergency pressure relief only with vacuum relief supplied by a separate breather valve. The 221PV provides both pressure and vacuum relief.

TECHNICAL DATA

Materials:	Carbon steel, aluminum, stainless steel
Sizes:	18", 20", 24" (450, 500, 600 mm)
Connections:	Drilled flange to API 650 or ANSI 150#
Pressure settings:	½ to 6 oz/in ² (22 to 264 kg/m ²)
Vacuum settings:	½ to 1 oz/in ² (22 to 44 kg/m ²)

VAREC 221 SERIES EMERGENCY PRESSURE RELIEF MANWAY COVERS

SPECIFICATIONS

Sizes

18", 20", 24"

Connections

Drilled to API 650 dimensions, flat face flange - standard
 Drilled to ANSI 150# dimensions, flat face flange - optional
 Special flange drilling requirements to DIN, JPI or JIS standards are available upon request.
 Consult your local sales representative for further details.

Setting ranges

Pressure See table below
 Vacuum ½ oz/in² to 1 oz/in²

Materials of construction

Base Carbon steel with stainless steel seating surface - standard
 Aluminum - optional
 316 Stainless steel - optional

Cover Low copper aluminum cover with carbon steel hinge arm - standard
 Carbon steel cover with carbon steel hinge arm - optional
 316 Stainless steel cover with 304 stainless steel hinge arm - optional

Diaphragm and pads NBR diaphragm with Neoprene pads - standard
 PTFE diaphragm with Neoprene pads - optional
 FKM diaphragm with FKM pads - optional

Vacuum insert
 (221PV only) NBR - standard
 PTFE - optional
 FKM - optional

Vacuum pallet assembly
 (221PV only) Aluminum - standard
 316 Stainless steel - optional

Hardware Spring retainer, cotter pin, sleeve, hinge pin, cap screws, nuts and washers -
 304 Stainless steel

PRESSURE SETTING CODES*

Size	Cover material	Below min. (counterweighted) - code 0			Min. - code 1			Above min. - code 2			Extra heavy - code 3		
		221P oz/in ²	221PV Alum trim oz/in ²	221PV SS trim oz/in ²	221P oz/in ²	221PV Alum trim oz/in ²	221PV SS trim oz/in ²	221P oz/in ²	221PV Alum trim oz/in ²	221PV SS trim oz/in ²	221P oz/in ²	221PV Alum trim oz/in ²	221PV SS trim oz/in ²
18"	Aluminum	0.5 - 1.0	0.5 - 1.1	0.5 - 1.35	1.0	1.1	1.35	1.0 - 3.0	1.1 - 4.5	1.35 - 4.5	3.0 - 6.0	4.5 - 6.0	4.5 - 6.0
18"	Carbon steel or 316 Stainless steel	2.5 - 3.5	-	2.75 - 3.75	3.5	-	3.75	3.5 - 6.0	-	3.75 - 6.0	-	-	-
20"	Aluminum	0.5 - 1.0	0.5 - 1.1	0.5 - 1.35	1.0	1.1	1.35	1.0 - 3.0	1.1 - 4.5	1.35 - 4.5	3.0 - 6.0	4.5 - 6.0	4.5 - 6.0
20"	Carbon steel or 316 Stainless steel	2.75 - 3.5	-	3.0 - 3.75	3.5	-	3.75	3.5 - 6.0	-	3.75 - 6.0	-	-	-
24"	Aluminum	0.5 - 1.0	0.6 - 1.1	0.85 - 1.35	1.0	1.1	1.35	1.0 - 3.0	1.1 - 4.5	1.35 - 4.5	3.0 - 6.0	4.5 - 6.0	4.5 - 6.0
24"	Carbon steel or 316 Stainless steel	3.0 - 3.5	-	3.25 - 3.75	3.5	-	3.75	3.5 - 6.0	-	3.75 - 6.0	-	-	-

NOTE

* For higher pressure settings see technical product data sheet for Figure 4210A (VCTDS-00308) or contact your sales representative.

VAREC 221 SERIES EMERGENCY PRESSURE RELIEF MANWAY COVERS

DIMENSIONS

PARTS

Item	Description
1	Base assembly
2	Cover
3	Cover ring
4	Cover pad
5	Diaphragm
6	Hinge arm assembly
7	Hinge pin
8	Loading weight
9	Weight mtg stud/assembly
10	Vacuum hood ^[1]
11	Vacuum pallet ^[1]
12	Vacuum spring ^[1]
13	Vacuum spring retainer ^[1]
14	Vacuum stem ^[1]
15	Vacuum post ^[1]
16	Vacuum screen ^[1]
17	Vacuum seat insert ^[1]
18	Vacuum insert retainer ^[1]
19	Counter weight assembly ^[2]

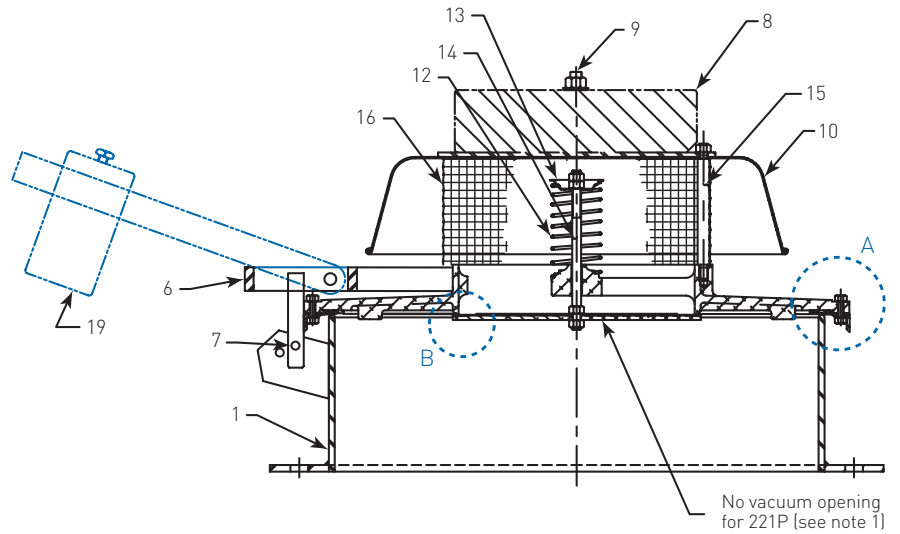

NOTES

1. Used only for the 221PV vacuum port.
2. Used only for the 'below minimum' pressure range.

DETAIL A
Enlarged

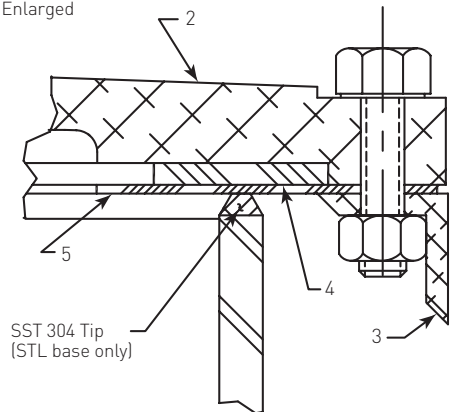

DETAIL B
Enlarged

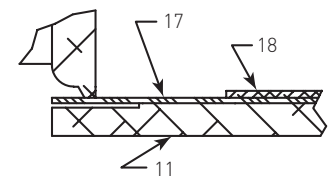

VAREC 221 SERIES EMERGENCY PRESSURE RELIEF MANWAY COVERS

DIMENSIONS

Specifications, inches (mm)

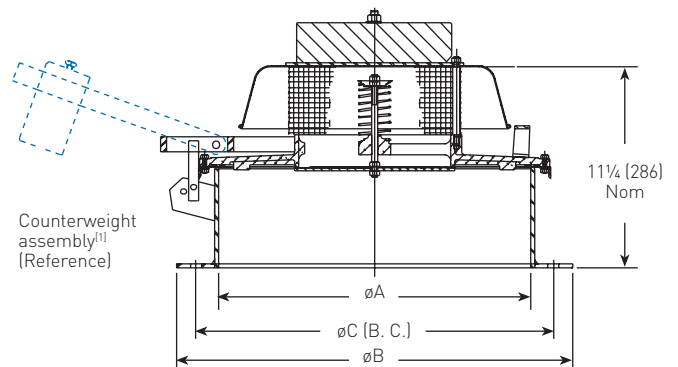
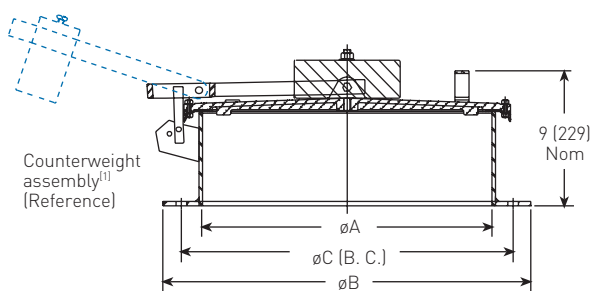
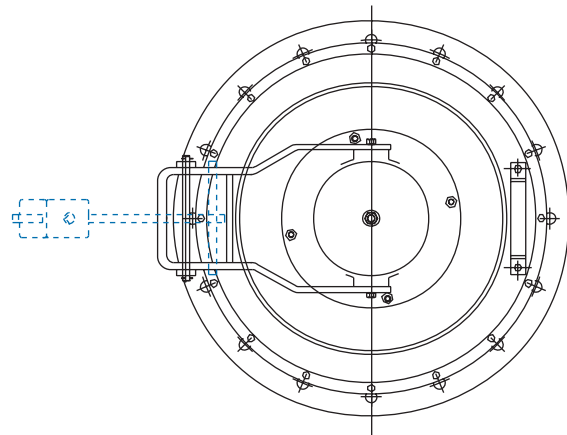
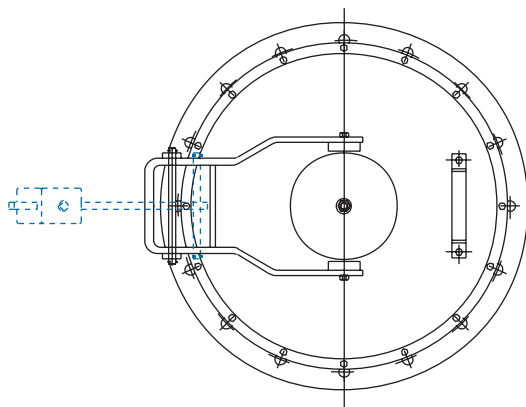

DRILLED FOR API 650 FLANGE

Size code	18	20	24
Nominal pipe size	18 (450)	20 (500)	24 (600)
A	18½ (470)	20½ (521)	24½ (622)
B	25 (635)	26 (660)	30 (762)
C	21½ (546)	23½ (597)	27½ (698)
Diameter of holes	¾ (19)	¾ (19)	¾ (19)
No. of holes	16	16	20

DRILLED FOR ANSI 150# FLANGE (optional)

Size code	18	20	24
Nominal pipe size	18 (450)	20 (500)	24 (600)
A	18½ (470)	20½ (521)	24½ (622)
B	25 (635)	27½ (698)	32 (813)
C	22¾ (578)	25 (635)	29½ (749)
Diameter of holes	1¼ (32)	1¼ (32)	1¾ (35)
No. of holes	16	20	20

NOTES

1. For pressure setting code 0 only.
2. Installation, mounting arrangement and dimensions are preliminary general information not to be used for construction. Certified drawings are available upon request.

VAREC 221 SERIES EMERGENCY PRESSURE RELIEF MANWAY COVERS

FLOW CAPACITY

18" 221P/PV relief manway cover pressure relief

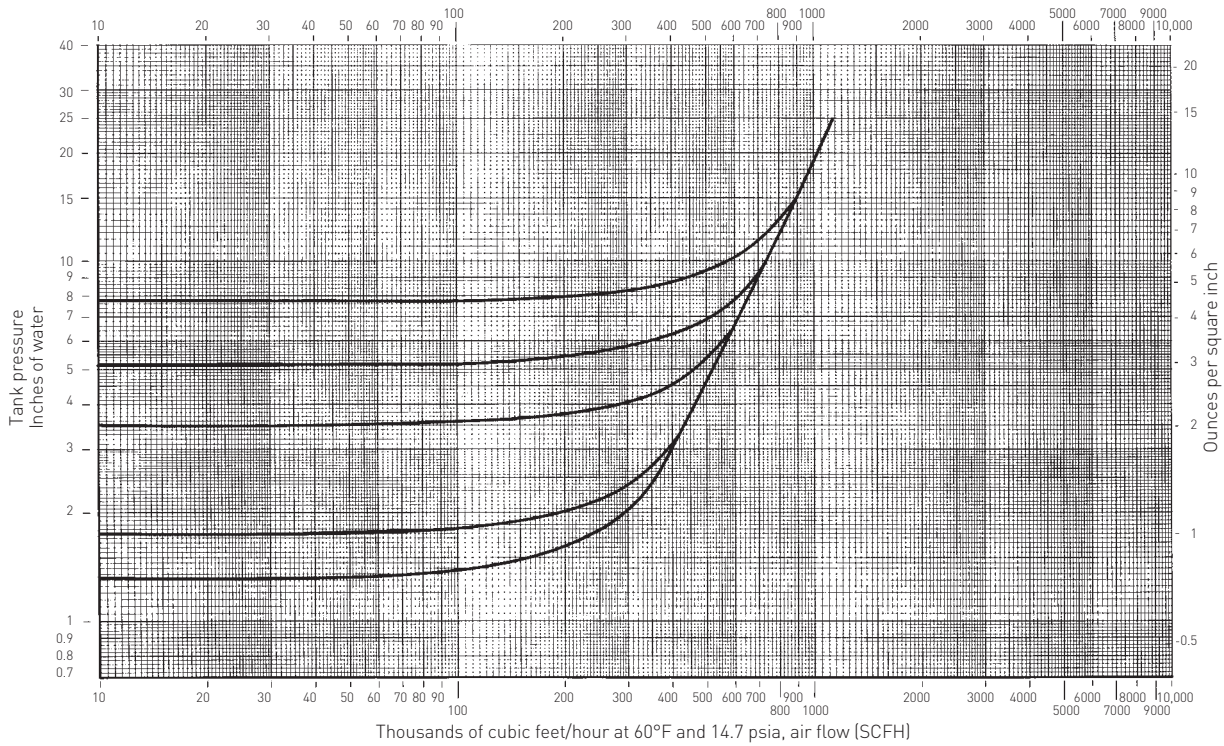

20" 221P/PV relief manway cover pressure relief

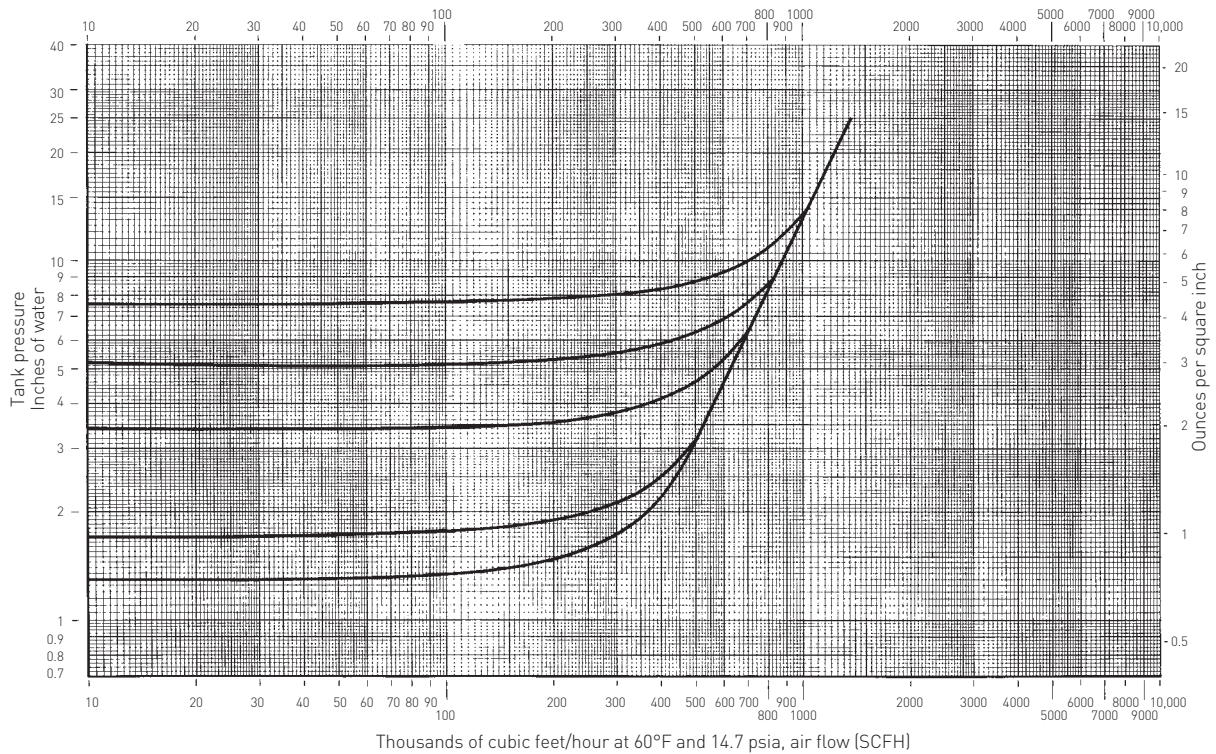

VAREC 221 SERIES EMERGENCY PRESSURE RELIEF MANWAY COVERS

FLOW CAPACITY

24" 221P/PV relief manway cover pressure relief

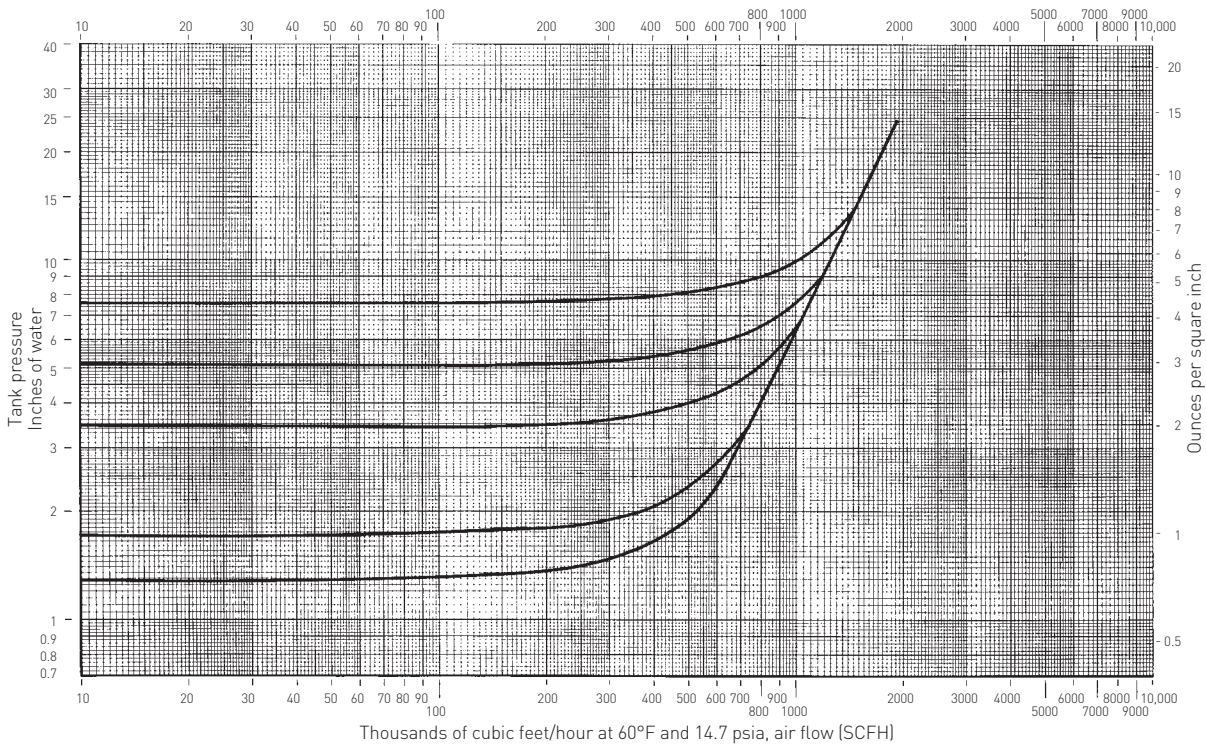

18", 20", and 24" 221P/PV relief manway cover vacuum relief

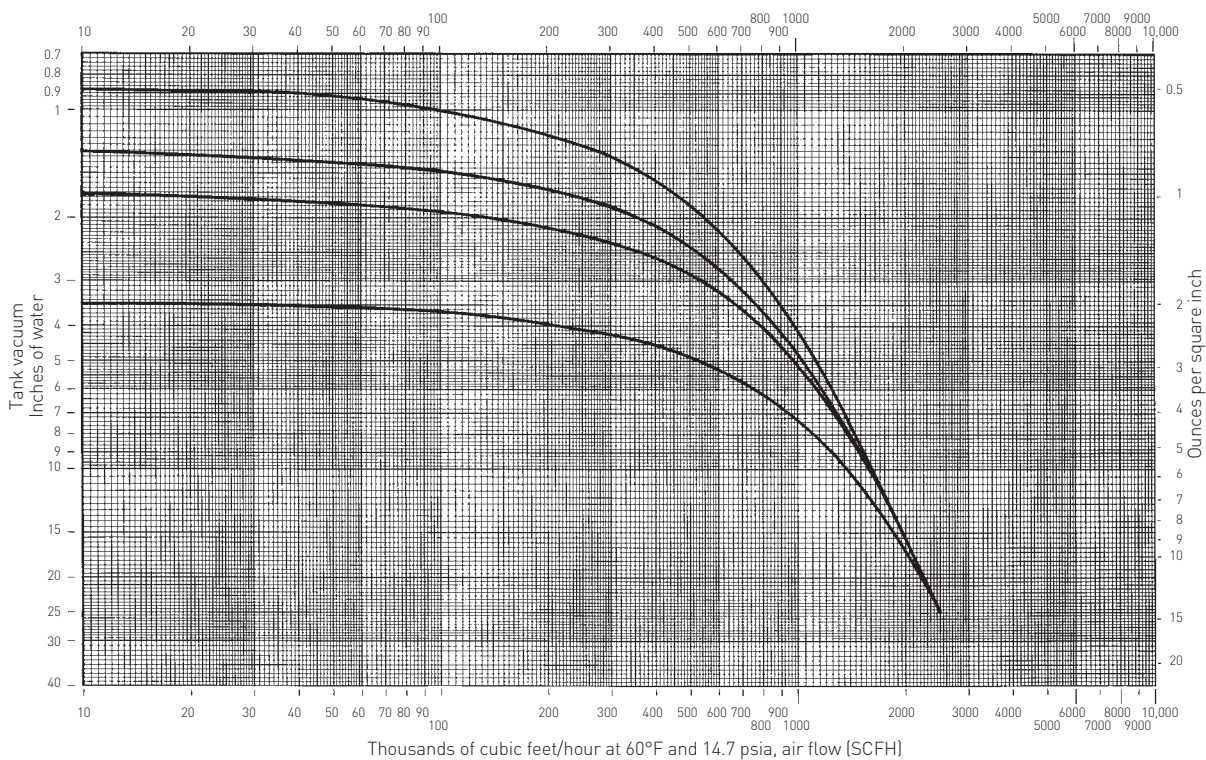

VAREC 221 SERIES EMERGENCY PRESSURE RELIEF MANWAY COVERS

ORDERING INFORMATION - PRESSURE AND VACUUM

SELECTION GUIDE

Example:		221	20	1PV1	B	1	1
Model							
221	Emergency pressure and vacuum relief manway cover						
Size							
18	18"						
20	20"						
24	24"						
Materials of construction							
	Base	Cover	Vacuum trim				
1PV1	Carbon steel	Aluminum	Aluminum				
1PV2	Carbon steel	Aluminum	316 Stainless steel				
2PV1	Aluminum	Aluminum	Aluminum				
2PV2	Aluminum	Aluminum	316 Stainless steel				
3PV2	Carbon steel	Carbon steel	316 Stainless steel				
4PV2	316 Stainless steel	316 Stainless steel	316 Stainless steel				
Diaphragm/cover pads/vacuum insert							
B	NBR/Neoprene/NBR						
T	PTFE/Neoprene/PTFE						
V	FKM/FKM/FKM						
Base flange drilling							
1	API 650						
2	ANSI 150#						
Pressure setting							
0	Below minimum (counterweighted)						
1	Minimum (standard)						
2	Above minimum						
3	Extra heavy						

Example: 20" Emergency pressure and vacuum relief manway cover with carbon steel base, aluminum cover, aluminum trim, NBR diaphragm and vacuum insert, API 650 drilling, minimum setting. Specify pressure and vacuum settings when ordering.

VAREC 221 SERIES EMERGENCY PRESSURE RELIEF MANWAY COVERS

ORDERING INFORMATION - PRESSURE ONLY

SELECTION GUIDE

Example:		221	20	1P0	B	1	1
Model							
221	Emergency pressure relief manway cover						
Size							
18	18"						
20	20"						
24	24"						
Materials of construction							
Cover							
1P0	Carbon steel/Aluminum						
2P0	Carbon steel/Aluminum						
3P0	Carbon steel/Carbon steel						
4P0	316 Stainless steel/316 Stainless steel						
Diaphragm/cover pads							
B	NBR/Neoprene						
T	PTFE/Neoprene						
V	FKM/FKM						
Base flange drilling							
1	API 650						
2	ANSI 150#						
Pressure setting							
0	Below minimum (counterweighted)						
1	Minimum (standard)						
2	Above minimum						
3	Extra heavy						

Example: 20" emergency pressure relief manway cover, carbon steel base with aluminum cover and NBR diaphragm, API 650 drilling, minimum setting. Specify pressure setting when ordering.